



Liebherr LTM 1080

Load Chart

Technical Data
Caractéristiques techniques

LTM 1080/1

Mobile Crane
Grue automotrice

Telescopic boom
Flèche télescopique

157 ft

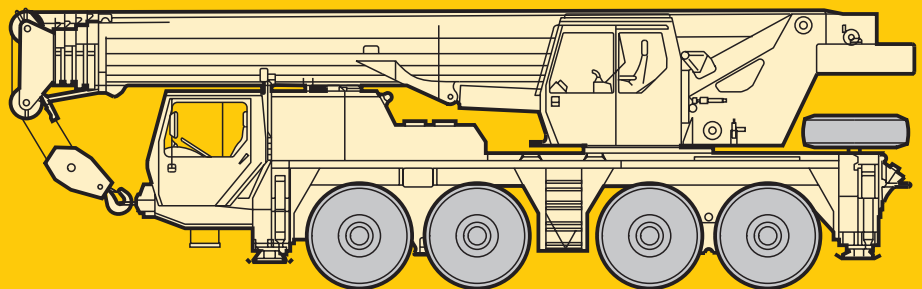

LIEBHERR

Lifting capacities on telescopic boom. Forces de levage à la flèche télescopique.

LTM 1080/1



35 ft – 157 ft



360°



35500 lbs



85%

ft	35 ft		47 ft	58 ft	69 ft	80 ft	92 ft	103 ft	114 ft	125 ft	136 ft	148 ft	157 ft	ft
	*													
9	183													9
10	169	149	148	137										10
11	158	141	140	131										11
12	148	133	133	126	110									12
13	139	126	126	121	107									13
14	131	120	120	116	104									14
15	124	114	114	111	101	84								15
16	117	109	109	106	98	81.5								16
17	111	104	104	102	95.5	79.5	67							17
18	105	99.5	99	97.5	93	77.5	65.5							18
20	94	90.5	90	89	87.5	73.5	63	54.5						20
22	85	83	83	82	80.5	69.5	60.5	52.4						22
24	77.5	76.5	76	75	73	66	58.1	50.4	43.5					24
26	71	70	69.5	68	65	62	55.7	48.4	42.2					26
28			64	62	58.9	56.9	53.1	46.6	41	35.5	30.3			28
30			58.6	56.3	53.3	51.6	50.1	44.9	39.8	34.5	29.6	26	20.9	30
32			54.2	51.4	48.8	47.3	46.3	43.1	38.8	33.5	28.9	25.6	20.5	32
34			50.2	47.4	45	43.7	42.9	41	37.4	32.6	28.2	25	20	34
36			46.4	44	41.7	40.5	39.9	38.7	36	31.6	27.5	24.3	19.5	36
38			42.7	40.5	38.4	37.4	36.9	36.4	34.5	30.7	26.9	23.6	19	38
40				37.4	35.4	34.5	34.2	34.1	32.9	29.8	26.2	23	18.6	40
45				31.1	29.8	29.1	28.9	29	28.5	27.4	24.1	21.2	17.5	45
50					25.2	24.7	24.6	24.9	24.6	24.6	22.3	19.7	16.4	50
55					21.2	21	21.1	21.4	21.3	21.8	20.6	18.3	15.4	55
60						18.9	18.2	18.6	18.5	19	19	17.1	14.4	60
65						17.4	15.4	17	16.2	16.8	16.8	15.9	13.5	65
70						15.9	14.1	15.8	14.3	14.9	15	14.8	12.8	70
75							12.9	14.4	13.3	13.1	13.3	13.6	12	75
80								12.9	12.4	11.5	12.3	12.2	11.3	80
85								11.4	11.7	10.8	11.5	10.6	10.5	85
90								10.2	11	10.2	10.3	9.5	9.4	90
95									10.2	9.5	9.3	8.5	8.4	95
100									9.5	8.8	8.4	7.6	7.5	100
105										8.1	7.6	6.9	6.7	105
110										7.4	6.9	6.2	6.1	110
115											6.3	5.6	5.5	115
120											5.8	5	4.9	120
125												4.5	4.4	125
130												4.1	4	130
135												3.7	3.6	135
140													3.2	140
I	0		0/0	46/0/0	92/0/0	92/0/0	92/0/0	92/0/0	92/0/0	92/0	92/46	92	100	I
II	0		46/0	46/0/0	46/0/0	92/0/0	92/0/0	92/92/0	92/92/46	92/92	92/92	92	100	II
III	0		0/0	0/0/0	0/0/0	0/92/0	46/92/46	46/92/92	92/92/92	92/92	92/92	92	100	III
IV	0		0/0	0/46/0	0/92/46	0/46/92	0/92/92	46/46/92	46/92/92	46/92	92/92	92	100	IV
% V	0		0/46	0/46/92	0/46/92	0/46/92	0/46/92	0/46/92	0/46/92	46/92	46/92	92	100	V

* over rear / en arrière

TAB 106139/106145

Remarks referring to load charts.

- The tabulated lifting capacities do not exceed 85% of the tipping load.
- The crane's structural steelwork is in accordance with DIN 15018, part 3. Design and construction of the crane comply with DIN 15018, part 2, and with F.E.M. regulations.
- The 85% overturning limit values take into account wind force 5 = wind speed 20 mph.
- Lifting capacities are given in kips.
- The weight of the hook blocks and hooks must be deducted from the lifting capacities.
- Working radii are measured from the slewing centreline.
- The lifting capacities given for the telescopic boom only apply if the folding jib is taken off.
- Lifting capacities are subject to modifications.
- Lifting capacities above 128 kips / 172 kips only with additional pulley block / special equipment.

Remarques relatives aux tableaux des charges.

- Les forces de levage indiquées ne dépassent pas 85% de la charge de basculement.
- La norme DIN 15018, 3ème partie est appliquée pour les charpentes. La construction de la grue est réalisée conformément à la norme DIN 15018, 2ème partie, et aux règles de la F. E. M.
- A 85% de la charge de basculement, il a été tenu compte d'un vent de force 5 = vitesse de vent 20 mph.
- Les forces de levage sont données en kips.
- Les poids des moufles et crochets doit être soustrait des charges indiquées.
- Les portées sont calculées à partir de l'axe de rotation.
- Les forces indiquées pour la flèche télescopique s'entendent fléchette dépliée déposée.
- Les forces de levage sont modifiables sans préavis.
- Forces de levage plus de 128 kips / 172 kips seulement avec un moufle complémentaire / équipement supplémentaire.

Lifting capacities are given in kips (1,000 lbs).





Lifting capacities on telescopic boom. Forces de levage à la flèche télescopique.

LTM 1080/1



35 ft – 157 ft



360°

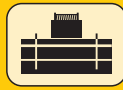

18740 lbs

85%

ft	35 ft	47 ft	58 ft	69 ft	80 ft	92 ft	103 ft	114 ft	125 ft	136 ft	148 ft	157 ft	ft
10	134	134	124										10
11	127	127	119										11
12	120	120	114	99.5									12
13	113	113	110	97									13
14	108	107	105	94.5									14
15	102	102	101	91.5	76								15
16	97	96.5	95.5	89	74								16
17	92	92	90.5	85	72	61							17
18	88	87.5	85.5	80	70.5	59.6							18
20	79	78.5	76	70	66	57.1	49.6						20
22	71.5	71	66.5	61.5	58.5	54.3	47.6						22
24	64	63.5	58.4	54.5	52	50.2	45.6	39.5					24
26	56.7	56.6	51.8	48.5	46.4	45	43.6	38.4					26
28		50	46.6	43.5	41.8	40.6	39.8	36.9	32.3	27.6			28
30		44	41.8	39	37.5	36.6	36	35.1	31.4	26.9	23.6	19	30
32		39.9	37.8	35.3	34	33.3	32.9	32.1	30.5	26.3	23.2	18.6	32
34		37.3	34.3	32.2	31.1	30.6	30.3	29.7	29	25.6	22.7	18.2	34
36		34.2	31.1	29.5	28.6	28.2	28	27.5	27.2	24.9	22.1	17.7	36
38		31.1	27.9	26.9	27.1	25.8	26.4	25.3	25.3	24.2	21.5	17.3	38
40			25.1	24.5	25.8	23.6	25.2	23.3	23.6	23.3	20.9	16.9	40
45			21.6	19.7	23	20.3	22.2	20.8	19.9	19.7	19.3	15.9	45
50				17.4	20	18.1	19.2	18.7	17.4	17.9	17	14.9	50
55				15.8	17.2	16.4	16.5	16.6	15.9	16	14.8	13.8	55
60					14.7	15	14.2	14.9	14.4	14	12.9	12.6	60
65					12.7	13.1	12.6	13.5	12.9	12.2	11.2	11	65
70					11.1	12.1	11.7	11.8	11	10.5	9.6	9.5	70
75						10.9	10.6	10.3	9.5	9.1	8.3	8.2	75
80							9.3	9	8.4	8	7.2	7.1	80
85								8.4	8.1	7.4	7	6.3	85
90								7.5	7.3	6.6	6.2	5.5	90
95									6.5	5.9	5.5	4.8	95
100									5.8	5.3	4.9	4.1	100
105										4.7	4.3	3.6	105
110										4.1	3.8	3.1	110
115											3.3	2.6	115
120												2.9	120
I	0	0/0	46/0/0	92/0/0	92/0/0	92/0/0	92/0/0	92/0/0	92/0	92/46	92	100	I
II	0	46/0	46/0/0	46/0/0	92/0/0	92/0/0	92/92/0	92/92/46	92/92	92/92	92	100	II
III	0	0/0	0/0/0	0/0/0	0/92/0	46/92/46	46/92/92	92/92/92	92/92	92/92	92	100	III
IV	0	0/0	0/46/0	0/92/46	0/46/92	0/92/92	46/46/92	46/92/92	46/92	92/92	92	100	IV
V	0	0/46	0/46/92	0/46/92	0/46/92	0/46/92	0/46/92	0/46/92	46/92	46/92	92	100	V

TAB 106142

Les forces de levage sont données en kips (1,000 lbs).

Lifting capacities on telescopic boom. Forces de levage à la flèche télescopique.

LTM 1080/1



35 ft – 58 ft



0°

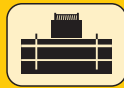

35500 lbs¹⁾
18740 lbs²⁾

85%

ft	35 ft		47 ft		58 ft		ft
	1)	2)	1)	2)	1)	2)	
10	39.6	37.8	41	39.3	41.8	40.1	10
11	36.9	35.2	38.4	36.7	39.2	37.5	11
12	34.5	32.9	36	34.4	36.8	35.2	12
13	32.2	30.7	33.8	32.3	34.6	33.1	13
14	30.3	28.8	31.8	30.4	32.6	31.2	14
15	28.4	27	30	28.6	30.8	29.4	15
16	26.8	25.4	28.3	27	29.2	27.8	16
17	25.3	24	26.8	25.6	27.7	26.4	17
18	23.9	22.7	25.5	24.3	26.3	25.1	18
20	21.3	20.1	22.9	21.7	23.7	22.6	20
22	19.1	18.1	20.7	19.7	21.6	20.5	22
24	17.2	16.2	18.8	17.8	19.7	18.7	24
26	15.5	14.6	17.1	16.1	18	17	26
28			15.6	14.7	16.5	15.6	28
30			14.3	13.4	15.1	14.3	30
32			13.1	12.3	14	13.2	32
34			12	11.3	12.9	12.2	34
36			11.1	10.4	12	11.3	36
38			10.2	9.5	11	10.3	38
40					10.2	9.5	40
45					8.4	7.8	45
I	0		0/ 0		46/ 0/ 0		I
II	0		46/ 0		46/ 0/ 0		II
III	0		0/ 0		0/ 0/ 0		III
IV	0		0/ 0		0/46/ 0		IV
V	0		0/46		0/46/92		V

TAB 106189 / 106191

Lifting heights. Hauteurs de levage.

LTM 1080/1

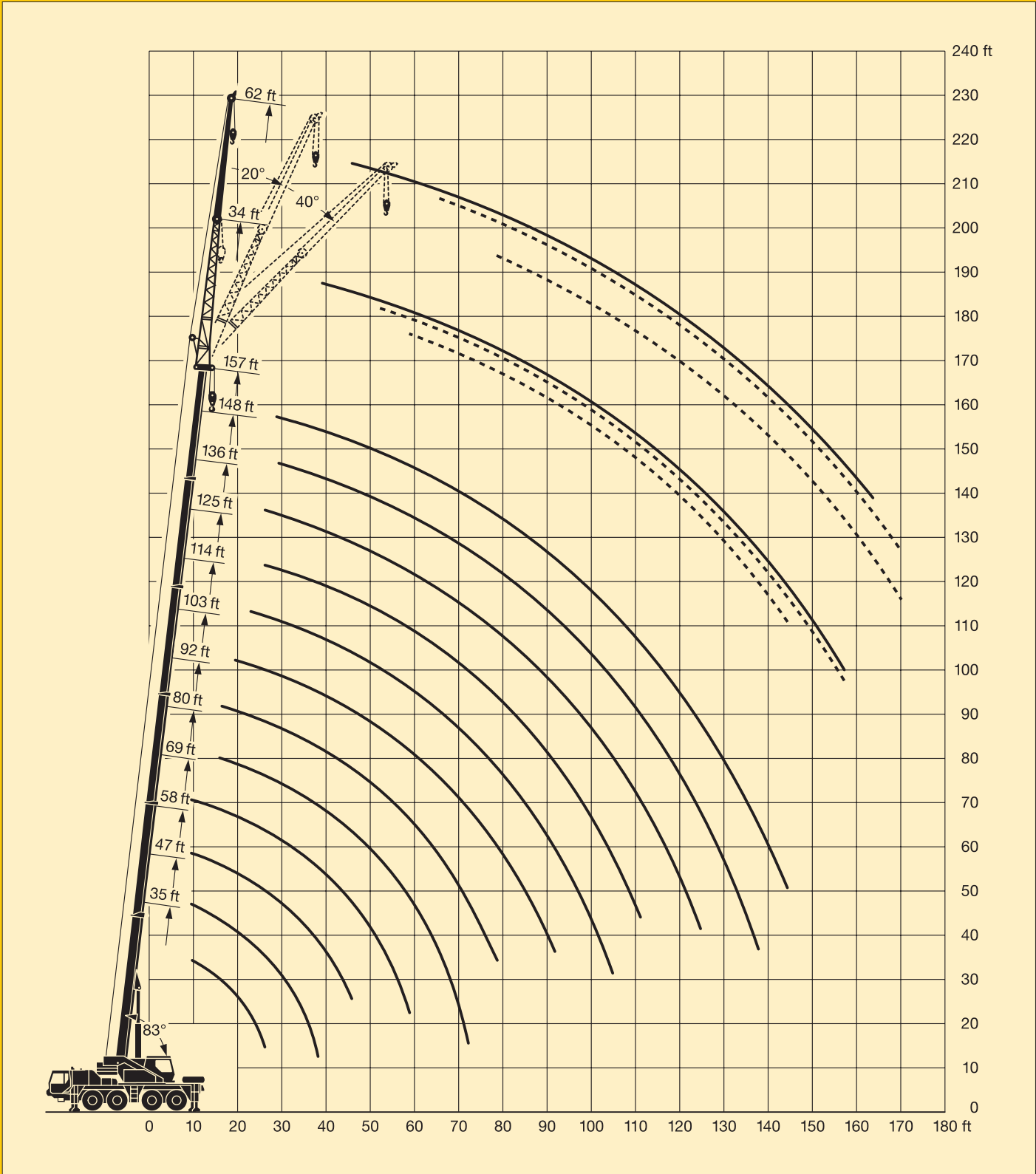

Lifting capacities on the folding jib. Forces de levage à la fléchette pliante.

LTM 1080/1



125 ft – 157 ft

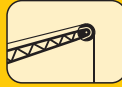

34 ft – 62 ft



360°

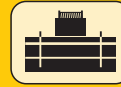

35500 lbs



85%

ft	125 ft						136 ft						148 ft						157 ft						ft			
	34 ft			62 ft			34 ft			62 ft			34 ft			62 ft			34 ft			62 ft						
	0°	20°	40°	0°	20°	40°	0°	20°	40°	0°	20°	40°	0°	20°	40°	0°	20°	40°	0°	20°	40°	0°	20°	40°				
34	21																									34		
36	20.7																									36		
38	20.5																									38		
40	20.3			8.1			16.8							13.6							9.9					40		
45	19.3			8			15.9							12.9							9.7					45		
50	17.9	15.5		7.8			15.1	13.4		7.2				12.2	10.9		6.5				9.4			5.8		50		
55	16.6	15.1	13.3	7.6			14.3	12.8	12.1	7				11.5	10.4		6.4				9.1	8.8		5.9		55		
60	15.4	14.6	13.1	7.3	6.2		13.4	12.2	11.5	6.9	5.9			10.9	9.9	9.5	6.4				8.7	8.5	8.4	5.9		60		
65	14.4	13.9	12.9	7.1	6.1		12.6	11.6	11	6.7	5.8			10.3	9.4	9.1	6.3				8.3	8.2	8.1	5.8		65		
70	13.4	13	12.7	7	5.9		11.8	11	10.5	6.6	5.7			9.8	9	8.7	6.2	5.3			8	7.9	7.9	5.6	5		70	
75	12.4	12.1	12.2	6.8	5.8	5.1	11	10.5	10.1	6.5	5.6			9.4	8.6	8.3	6.1	5.2			7.7	7.6	7.6	5.4	4.9		75	
80	11.4	11.3	11.4	6.6	5.7	5	10.3	10.1	9.7	6.3	5.5	4.9		8.9	8.2	8	5.9	5.1	4.6		7.4	7.4	7.3	5.3	4.9	4.3	80	
85	10.1	10.5	10.7	6.5	5.6	4.9	9.6	9.7	9.3	6.2	5.4	4.9		8.5	7.9	7.7	5.8	5.1	4.6	7	7.1	7.1	5.1	4.8	4.3		85	
90	9	9.6	10	6.3	5.5	4.9	8.9	9.1	9	6.1	5.3	4.8		8.1	7.6	7.4	5.7	5	4.6	6.7	6.8	6.9	4.9	4.8	4.3		90	
95	8	8.7	9.1	6.2	5.4	4.8	8.1	8.5	8.6	6	5.2	4.8		7.7	7.3	7.1	5.5	4.9	4.5	6.4	6.5	6.7	4.8	4.7	4.2		95	
100	7.2	7.7	8.2	6	5.3	4.8	7.2	7.8	8.1	5.9	5.1	4.8		7.2	7	6.9	5.3	4.9	4.5	6.1	6.2	6.4	4.6	4.5	4.2		100	
105	6.4	6.9	7.3	5.8	5.2	4.8	6.6	6.9	7.3	5.8	5	4.7		6.6	6.7	6.6	5.1	4.8	4.5	5.8	6	6.1	4.5	4.4	4.2		105	
110	5.9	6.2	6.5	5.6	5.1	4.7	6.3	6.3	6.6	5.7	4.9	4.7		5.9	6.3	6.5	4.9	4.7	4.5	5.6	5.7	5.8	4.4	4.3	4.2		110	
115	5.6	5.8	5.8	5.5	5	4.7	5.9	6	6.1	5.5	4.9	4.6		5.3	5.7	6	4.7	4.5	4.4	5.1	5.4	5.6	4.2	4.2	4.1		115	
120	5.3	5.4		5.1	4.9	4.6	5.4	5.7	5.8	5.1	4.8	4.6		4.7	5.1	5.4	4.5	4.4	4.3	4.5	5	5.2	4	4	4.1		120	
125	5	5.1		4.6	4.9	4.6	4.9	5.2		4.6	4.8	4.6		4.2	4.6	4.8	4.4	4.2	4.2	4	4.4	4.7	3.9	3.9	3.9		125	
130	4.7	4.8		4.2	4.8	4.6	4.4	4.7		4.3	4.7	4.6		3.7	4.1	4.3	4.1	4.1	4.1	3.6	3.9	4.2	3.7	3.8	3.8		130	
135	4.5	4.5		3.9	4.4	4.6	4	4.3		4.1	4.3	4.5		3.3	3.6	3.8	3.7	3.9	4	3.1	3.5	3.7	3.5	3.7	3.7		135	
140	4.1	4.2		3.7	3.9	4.3	3.6	3.8		3.9	3.9	4.2		2.9	3.2		3.3	3.8	3.9	2.8	3.1	3.2	3.1	3.5	3.6		140	
145	3.8			3.5	3.6		3.3	3.4		3.6	3.7	3.9		2.6	2.8		3	3.5	3.8	2.4	2.7		2.8	3.4	3.4		145	
150	3.4			3.3	3.4		2.9	3.1		3.3	3.6	3.7		2.2	2.5		2.6	3.2	3.5	2.1	2.3		2.4	3	3.2		150	
155				3.1	3.2		2.6			3	3.3	3.5		1.9	2.1		2.3	2.8	3.1	1.7	2		2.1	2.7	3		155	
160				2.9	3					2.7	3			1.5	1.7		2	2.5	2.8		1.7		1.8	2.3	2.7		160	
165				2.7	2.8					2.4	2.7						1.7	2.2					1.6	2	2.3		165	
170				2.6	2.6					2.1	2.4						1.5	1.9					1.3	1.7	2		170	
175				2.3						1.8	2.1							1.6							1.4			175
180										1.6																		180
I				92/0						92/46							92						100			I		
II				92/92						92/92							92						100			II		
III				92/92						92/92							92						100			III		
IV				46/92						92/92							92						100			IV		
V				46/92						46/92							92						100			V		

TAB 106161 / 106167 / 106173

Lifting capacities on the folding jib. Forces de levage à la fléchette pliante.

LTM 1080/1



125 ft – 157 ft

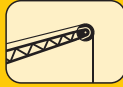

34 ft – 62 ft



360°

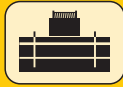

18740 lbs

85%

ft	125 ft						136 ft						148 ft						157 ft						ft	
	34 ft			62 ft			34 ft			62 ft			34 ft			62 ft			34 ft			62 ft				
	0°	20°	40°	0°	20°	40°	0°	20°	40°	0°	20°	40°	0°	20°	40°	0°	20°	40°	0°	20°	40°	0°	20°	40°		
34	19																									34
36	18.9																									36
38	18.7																									38
40	18.4			7.4			15.2							12.4						9						40
45	17.5			7.3			14.4							11.7						8.9						45
50	15.7	14.1		7.1			13.7	12.2		6.6				11.1	9.9		5.9			8.6				5.3		50
55	13.7	13.7	12.1	6.9			12.8	11.6	11	6.4				10.5	9.4		5.8			8.2	8			5.3		55
60	11.9	13.1	11.9	6.7	5.6		11.7	11	10.4	6.2	5.3			9.9	9	8.7	5.8			7.9	7.7	7.7		5.4		60
65	10.3	11.4	11.7	6.5	5.5		10.2	10.5	10	6.1	5.2			9.4	8.6	8.2	5.7			7.6	7.5	7.4		5.3		65
70	9	10	10.7	6.3	5.4		8.9	9.7	9.6	6	5.2			8.7	8.2	7.9	5.6	4.8		7.3	7.2	7.1	5.1	4.5		70
75	8.3	8.7	9.5	6.2	5.3	4.6	8.4	8.7	9	5.9	5.1			7.8	7.8	7.6	5.5	4.8		7	6.9	6.9	4.9	4.5		75
80	7.8	7.6	8.3	6	5.2	4.6	7.7	7.6	8.3	5.8	5	4.5		6.8	7.4	7.3	5.4	4.7	4.2	6.6	6.7	6.7	4.8	4.4	3.9	80
85	7.3	6.9	7.2	5.9	5.1	4.5	6.8	7.2	7.2	5.6	4.9	4.4		5.9	6.7	7	5.3	4.6	4.2	5.7	6.4	6.5	4.6	4.4	3.9	85
90	6.5	6.6	6.5	5.5	5	4.5	6	6.5	6.7	5.4	4.8	4.4		5.2	5.9	6.3	5.2	4.5	4.1	4.9	5.7	6.1	4.5	4.3	3.9	90
95	5.8	6.2	6.3	5	4.9	4.4	5.2	5.8	6.2	5	4.7	4.3		4.5	5.1	5.6	4.8	4.5	4.1	4.2	4.9	5.5	4.3	4.3	3.9	95
100	5.1	5.6	5.9	4.7	4.8	4.4	4.6	5.1	5.5	4.7	4.6	4.3		3.8	4.4	4.9	4.3	4.4	4.1	3.6	4.2	4.7	4	4.1	3.8	100
105	4.5	4.9	5.2	4.5	4.7	4.3	4	4.5	4.8	4.5	4.6	4.3		3.2	3.8	4.2	3.7	4.4	4.1	3	3.6	4.1	3.5	4	3.8	105
110	4	4.4	4.6	4.3	4.2	4.3	3.5	3.9	4.2	4	4.2	4.2		2.7	3.3	3.6	3.2	4.1	4.1	2.5	3.1	3.5	3	3.9	3.8	110
115	3.5	3.9	4.1	4	4	4.1	3	3.4	3.7	3.5	4	4.1		2.3	2.8	3.1	2.7	3.7	4	2.1	2.6	3	2.5	3.5	3.8	115
120	3.1	3.4		3.5	3.8	3.8	2.6	3	3.2	3	3.8	3.9		1.8	2.3	2.6	2.3	3.2	3.8		2.1	2.5	2.1		3.6	120
125	2.7	3		3.1	3.7	3.7	2.2	2.5		2.6	3.3	3.7		1.8	2.1	1.9	2.7	3.3			2			2.5	3.2	125
130	2.3	2.5		2.8	3.3	3.6	1.9	2.2		2.3	2.9	3.4		1.4	1.7	1.5	2.3	2.9			1.5			2.1	2.8	130
135	1.9	2.1		2.4	2.9	3.3	1.5	1.8		1.9	2.5	3						1.9	2.5					1.7	2.3	135
140	1.6	1.8		2.1	2.6	2.9				1.6	2.2	2.6						1.5	2.1						1.9	140
145				1.8	2.2						1.9	2.2														145
150				1.5	1.9						1.5	1.9														150
155				1.6								1.5														155
I	92/ 0						92/46						92						100						I	
II	92/92						92/92						92						100						II	
III	92/92						92/92						92						100						III	
IV	46/92						92/92						92						100						IV	
V	46/92						46/92						92						100						V	

TAB 106158 / 106164 / 106170

Dimensions. Encombrement.

LTM 1080/1

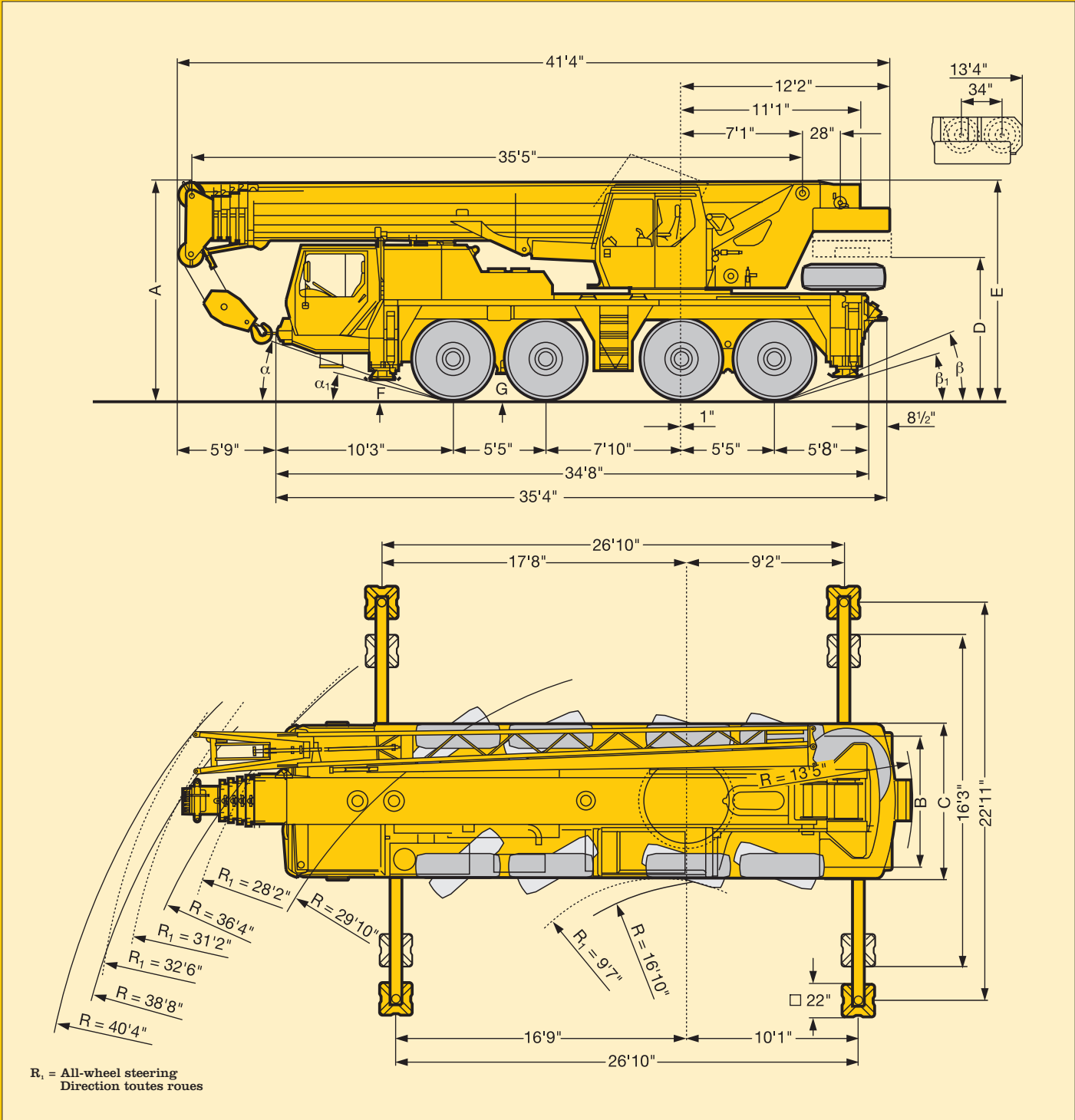

16.00 R 25	Dimensions / Encombrement											
	A	A	B	C	D	E	F	G	α	α_1	β	β_1
	12'8"	12'4"	7'7"	9'	9'6"	12'8"	13'1/3"	15'1/3"	19°	16°	23°	16°

* lowered / abaissé

** with folding jib / avec fléchette pliante

Weights. Poids.

LTM 1080/1



Axle Essieu	1	2	3	4	Total weight Poids total
lbs	26400	26400	26400	26400	105600 ¹⁾

¹⁾ with 18740 lbs counterweight / avec contrepoids 18740 lbs



Load (kips) Forces de levage kips	No. of sheaves Poulies	No. of lines Brins	Weight lbs Poids lbs
176	7	14	950
128	5	10	730
84	3	7	880
35	1	3	520
12.5	-	1	240

Working speeds. Vitesses.



	1	2	3	4	5	6	R ₁	R ₂	
	6.0	9.2	14.4	22.4	32.9	49.7	6	14.4	35 %
	3.9	6	9.3	14.5	21.2	33	3.9	6	60 %
	16.00 R 25								



Drive Mécanismes	infinitely variable en continu	Rope diameter / Rope length Diamètre du câble / Longueur du câble	Max. single line pull Effort au brin maxi.
	0 - 426 ft/min single line ft/min au brin simple	$\frac{2}{3}$ " / 820'	12800 lbs
	0 - 426 ft/min single line ft/min au brin simple	$\frac{2}{3}$ " / 690'	12800 lbs
	0 - 2.0 rpm		
	approx. 48 seconds to reach 83° boom angle env. 48 s jusqu'à 83°		
	approx. 240 seconds for boom extension from 35 ft - 157 ft env. 240 s pour passer de 35 ft - 157 ft		

Crane carrier.

LTM 1080/1

Frame:	Liebherr designed and manufactured, box-type, torsion resistant design of high-tensile fine grained structural steel.
Outriggers:	4-point support, all-hydraulic horizontal and vertical operation.
Engine:	6-cylinder Diesel engine, make Liebherr, type D 9406 TI-E, watercooled, 320 kW (435 HP) at 2100 min ⁻¹ acc. to ECE-R 24.03 and 2001/27/EG (Euro 3), max. torque 1900 Nm at 1100 – 1400 min ⁻¹ , engine management with Liebherr data bus. Fuel tank: 400 l.
Transmission:	ZF power shift gear, with torque converter, lock-up and integrated off-road ratio, additional activation of front wheel drive, 6 forwards and 2 reverse speeds.
Axles:	All axles steered. Axles 1, 3 and 4 with planetary gears and differential locks.
Suspension:	All axles with hydropneumatic suspension and hydraulic locking facility.
Tyres:	8 tyres. Tyre size: 16.00 R 25.
Steering:	Front axles mechanically steered, with hydraulic power assistance and stand-by steering pump. Rear axles hydraulically steered. All axles steered hydrostatically from crane cab. Steering acc. to EC directive 70/311/EEC.
Brakes:	Service brake: All-wheel servo-air brake, dual circuit system. Hand brake: Spring-loaded, acting on all wheels of axles 2, 3 and 4. Sustained-action brake: Exhaust retarder with additional Liebherr braking system Brakes acc. to EC directive 71/320/EEC.
Driving cab:	Two-men driving cab, steel sheet design, with dipping varnish and powder coating. With control elements and instruments for driving.
Electrical system:	Control of the electrical and electronical components by modern data bus technique. 24 Volt DC, 2 batteries, lighting according to traffic regulations.

Crane superstructure.

Frame:	Liebherr-made torsion resistant, welded construction of high-tensile structural steel, linked to carrier by a three-row roller slewing ring for 360° continuous rotation.
Crane drive:	Diesel-hydraulic with 1 double axial piston variable displacement pump with automatic capacity control, 1 double gear pump, driven by the carrier Diesel engine, open oil circuits with electrically controlled "load sensing", operation of 4 movements simultaneously.
Crane control:	By 2 control levers (joystick type) and by electronic speed variation of Diesel engine, electric pilot control with stepless control of all crane motions. Liebherr data bus technique for data transfer.
Hoist gear:	Axial piston fixed displacement motor, hoist drum with integrated planetary gear and spring-loaded static brake, actuation by open oil circuit.
Luffing gear:	1 differential ram with pilot operated brake valve.
Slewing gear:	Hydraulic motor, planetary gear with spring-loaded static brake, actuation by open oil circuit. Continuous control of slewing speed.
Crane cab:	All-steel construction, fully galvanized, with safety glass, heater, operating and control elements. Cab tiltable backwards.
Safety devices:	LICCON safe load indicator, hoist limit switch, safety valves against rupture of pipes and hoses.
Telescopic boom:	Buckling resistant and torsion-proof design of high tensile steel with oviform boom profile, 1 base section and 5 telescopic sections. All telescopic sections extendable hydraulically and independently from one another. Rapid-cycle telescoping system "TELEMATIK". Boom length: 35 ft – 157 ft.
Counterweight:	18740 lbs basic counterweight.
Electric system:	Control of the electrical and electronical components by modern data bus technique.

Complementary equipment.

Folding jib:	34 ft – 62 ft long, for mounting on telescopic boom at 0°, 20° and 40°.
2nd hoist gear:	For two-hook operation, or with folding jib in case main hoist shall remain reeved.
Additional counterweight:	16760 lbs for a total counterweight of 35500 lbs.
Drive 8 x 8:	Axle 2 additionally driven.

Other equipments available on request.

Châssis porteur.

LTM 1080/1

Châssis:	Fabrication Liebherr, construction en caisson indéformable, en acier à haute résistance à grains fins.
Stabilisateurs:	Calage en 4 points, à telescopage horizontal et vérinage entièrement hydrauliques.
Moteur:	Diesel 6 cylindres, marque Liebherr, type D 9406 TI-E, refroidi par eau, puissance 320 kW (435 ch) à 2100 min ⁻¹ selon ECE-R 24.03 et 2001/27/EG (Euro 3), couple max. 1900 Nm à 1100 – 1400 min ⁻¹ , gestion électronique par Liebherr bus de données. Réservoir à carburant: 400 l.
Boîte de vitesse:	ZF à changement de rapports en charge avec convertisseur de couple, lock-up et étage gamme terrain intégré et actionnement additionnel de l'entraînement de l'essieu avant. 6 rapports avant et 2 rapports arrières.
Essieux:	Tous les essieux sont directeurs. Les essieux 1, 3 et 4 avec planétaires et blockages de différentiels.
Suspension:	Tous les essieux sont suspendus hydropneumatiquement et blocable hydrauliquement.
Pneumatiques:	8 roues. Taille: 16.00 R 25.
Direction:	Direction mécanique à assistance hydraulique des essieux avant. Pompe de secours. Direction des essieux arrières enclenchable hydrauliquement. Direction hydrostatique de tous les essieux à commande depuis la cabine du grutier. Direction selon directive CE 70/311/CEE.
Freins:	Frein de service: servo-frein pneumatique à deux circuits indépendants agissant sur toutes les roues. Frein à main: par cylindres à ressorts, agissant sur les roues des essieux 2, 3 et 4. Frein à régime continu: Ralentisseur sur échappement avec système de freinage additionnel Liebherr. Freins selon directive CE 71/320/CEE.
Cabine:	Cabine conducteur bi-place en tôle d'acier revêtue anti-corrosion par bain de cataphorèse, peinte par poudrage polyester et cuisson au four comportant tous les organes de commande et de contrôle nécessaire à la conduite du véhicule.
Installation électrique:	Composants électriques et électroniques reliés entre eux par bus de données moderne. Courant continu 24 Volts, 2 batteries, éclairage conforme au code de la route.

Partie tournante.

Châssis:	Construction mécanosoudée en tôle d'acier à haute résistance à grains fins. Reliée au porteur par une couronne d'orientation à 3 rangées de rouleaux. Rotation totale 360°.
Entraînement:	Diesel hydraulique avec 1 pompe double à débit variable et régulation de puissance automatique, 1 pompe à engrenages double, entraînés par le moteur Diesel du porteur, circuits hydrauliques ouverts avec "load sensing", régulé électriquement. 4 mouvements simultanés praticables.
Commande:	Par deux manipulateurs (type manche à balai) dans la cabine du grutier, et par variation électronique du régime du moteur Diesel, servo-commande électrique avec régulation progressive en continu de tous les mouvements en simultané. Technique de transmission par bus de données Liebherr.
Treuil:	Moteur hydraulique à cylindree constante, treuil à réducteur planétaire incorporé et frein d'arrêt à ressort, en circuit hydraulique ouvert.
Relevage de flèche:	1 vérin différentiel à soupape pilotage de freinage.
Orientation:	Moteur hydraulique, réducteur planétaire, frein d'arrêt commandé par ressort en circuit hydraulique ouvert. Vitesse d'orientation réglable en continu.
Cabine de grue:	Entièrement en tôle d'acier avec vitrage de sécurité, chauffage, tous les instruments de commande et de contrôle. Cabine inclinable sur l'arrière.
Sécurités:	Contrôleur de charge LICCON, fin de course crochet haut, clapets de sécurité en cas de ruptures de flexibles.
Flèche télescopique:	Construction en acier à haute résistance à grains fins à profil oval à haute résistance au flambage, 1 élément de base et 5 éléments télescopiques. Chaque élément télescopable indépendamment de l'autre. Système de télescope «Télématik» séquentiel rapide. Télescope: 35 ft à 157 ft.
Contrepoids:	Contrepoids de base 18740 lbs.
Circuit électrique:	Composants électriques et électroniques reliés entre eux par bus de données moderne.

Équipement optionnel.

Fléchette pliante:	34 ft à 62 ft de long, pour montage à la flèche télescopique à 0°, 20° ou 40°.
Deuxième treuil:	Pour le levage avec 2 crochets ou pour le travail avec fléchette pliante lorsque le câble de levage principale reste mouflé.
Contrepoids complémentaire:	16760 lbs pour une masse totale de 35500 lbs.
Entraînement 8 x 8:	Essieu 2 est entraîné additionnellement.

Autres équipements supplémentaires sur demande.



Subject to modification. / Sous réserve de modifications.

TP 273c. US. 1.99

Please contact

Veillez prendre contact avec

LIEBHERR-WERK EHINGEN GMBH

D-89582 Ehingen/Donau, Telefon (0 73 91) 5 02-0, Telefax (0 73 91) 5 02-33 99

www.liebherr.com, E-mail: info@lwe.liebherr.com

CD- 

TUTT BRYANT





Tutt Bryant Heavy Lift & Shift Locations

Western Region

Perth (South Guildford), WA
 Ph: 08 9230 0500
 Email: per@tuttbryant.com.au

Karratha, WA
 Ph: 08 9143 0089
 Email: karratha@tuttbryant.com.au

Northern Region

Darwin (Berrimah), NT
 Ph: 08 8924 1333
 Email: dwn@tuttbryant.com.au

Eastern Region

Brisbane (Ormeau), QLD
 Ph: 07 5540 8700
 Email: bne@tuttbryant.com.au

Sydney (Sydney Olympic Park), NSW
 Ph: 02 9646 6000
 Email: aces@tuttbryant.com.au

Melbourne (Dandenong), VIC
 Ph: 03 9554 0300
 Email: mel@tuttbryant.com.au

Hunter Region

Muswellbrook, NSW
 Ph: 02 6541 6444
 Email: mck@tuttbryant.com.au

Online

www.tuttbryant.com.au



TUTT BRYANT
 HEAVY LIFT & SHIFT

