



SANY

Quality Changes the World



SANY CRAWLER CRANE SCC 4000E

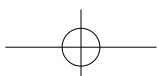



CRAWLER CRANE

CONTENT

P3

SCC4000E Crawler Crane
 Outline Dimensions (Rexroth)
 Main Technical Features
 Performance Data
 Transport Dimensions

P14

Specifications

Upperworks
 Lowerworks
 Operation Device
 Safety Devices
 Assembly/Disassembly Diagram

P21

Operating Condition Combination

Operating Condition Combination
 H Operating Condition
 HDB Operating Condition
 LJ Operating Condition
 LJDB Operating Condition
 HJ Operating Condition
 HJDB Operating Condition
 H_L Operating Condition
 SF_L Operating Condition

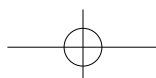
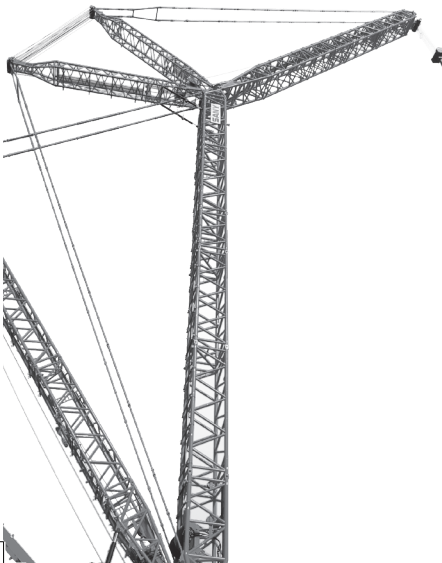

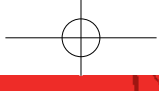

SCC4000E

04	Outline Dimensions
07	Main Technical Features
08	Performance Data
09	Transport Dimensions



OUTLINE DIMENSIONS(REXROTH)

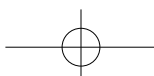
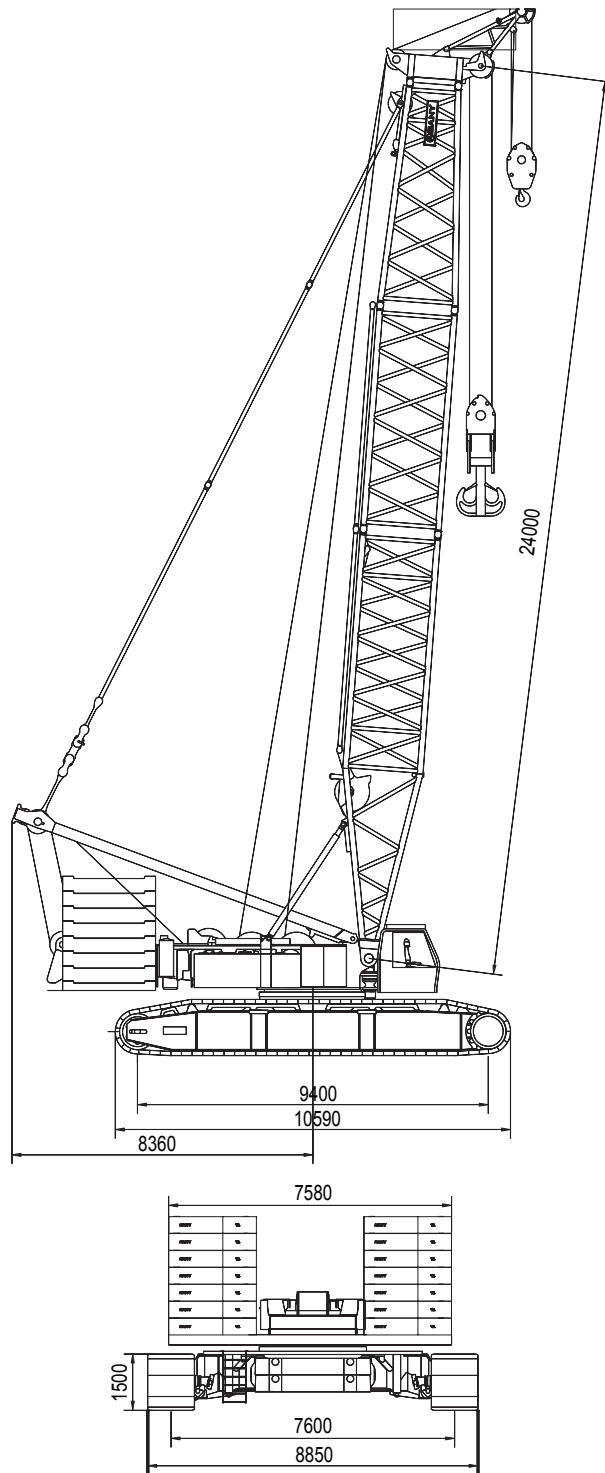



OUTLINE DIMENSIONS (REXROTH)

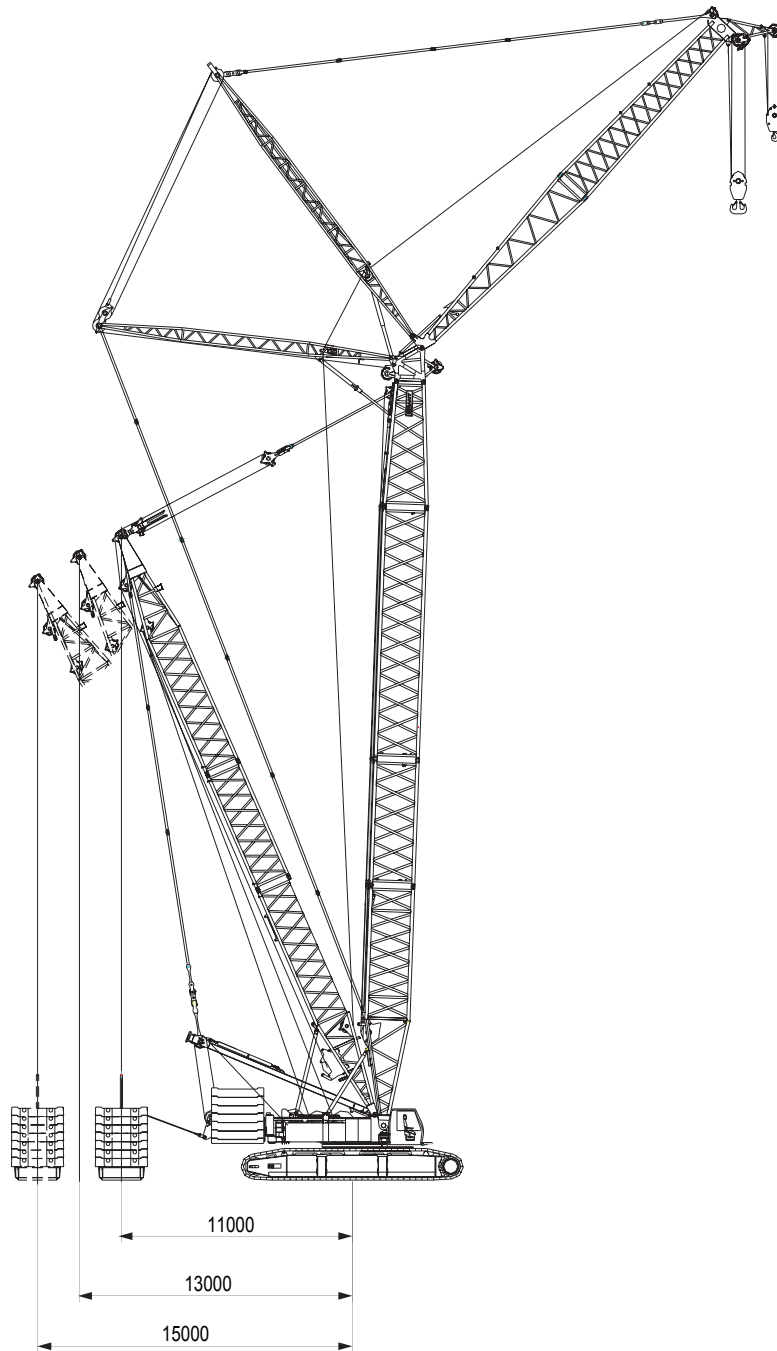

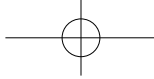

OUTLINE DIMENSIONS (REXROTH)

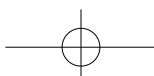
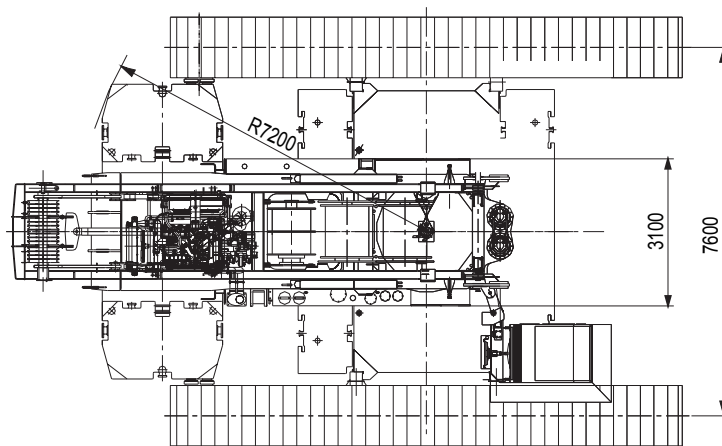
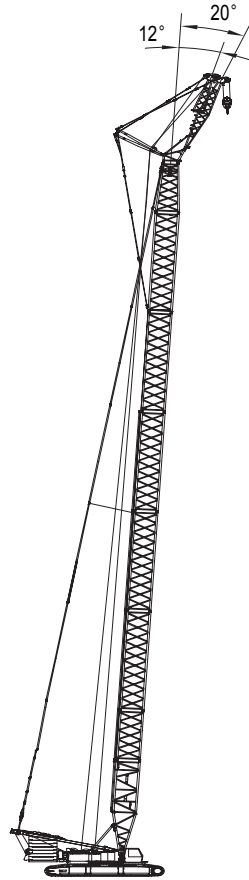



MAIN TECHNICAL FEATURES

1. Safety control system:

Two convenient and reliable modes of operation: working and installation, with real-time level display, stop operation braking away from machine, electrical emergency control, anti-lightning protection, automatically walk switches, CCTV monitoring function, complete safety and supervision system;

2. Excellent operating performance:

Load-sensing, limit load regulation and electro-hydraulic proportional micro-speed control make each micro-movement extremely good and operation more stable;

3. Reliable functions assurance:

Key components adopts famous international brands; sufficient safety margin for structural and mechanical design; control system can operate stably in harsh environments such as cold, high temperature, altitude and sandy conditions;

4. Powerful lifting capacity:

The maximum lifting capacity of boom is 400t, and the maximum lifting moment under superlift operating condition is 5220t·m;

5. Flexible configuration combination of operating condition:

There are up to 11 kinds of freely-combined operating conditions; the boom length of H operation condition can reach 117m, the boom combination under tower operating condition 84+87m, and boom combination under the operating condition of fixed short jib 87+9m;

6. Large chassis design:

The large chassis with a 7.6m gauge ensures excellent machine and job stability within the range of 360 ° rotation;

7. Efficient self-assembly and disassembly technology:

The whole machine can be assembled and disassembled by itself, and it takes only 3 hours to assemble the basic machine; the patented synchronic control technology of one-key lifted mast has independent property right;

8. Traveling with 100% load:

Powerful tracking force and travel smoothness bring the advantages of crawler crane into full play;

9. Reliable transmission system:

The hydraulic technology with internationally renowned brands, and the system is stable and more reliable;

10. Convenient maintenance technology:

It takes approximately no more than 10min/person to adjust; no more than 30min/person for daily maintenance; no more than 2h/person to repair. GPS remote monitoring system is optional for maintenance and management;

11. Optimized transport solution:

The whole machine has a maximum transport weight of 55t and a maximum transport width of 3.1m;

12. Broad adaptability:

Comply with the CE and North American certification requirements, as well as European and U.S. Emission of hazardous substance: meet the Non-highway Europe III standard.

PERFORMANCE DATA

Main performance data of SCC4000E crawler crane

Performance Index		Unit	Data
Boom operating condition	Maximum rated capacity	t	400
	Maximum rated load toque	t·m	2090
	Boom length	m	24~84
	Boom luffing angle	°	30~84
HD(B) Operating Condition of Boom with Superlift	Maximum rated capacity	t	400
	Max. lifting torque	t·m	5220
	Boom length	m	30~117
	Superlift mast length	m	30
LJ Operating Condition of Luffing Jib	Maximum rated capacity	t	126
	Boom length	m	36~54
	Jib length	m	27~63
	Fully extended boom + fully extended luffing jib	m	54+63
	Boom luffing angle	°	67~87 (stepless)
LJD(B) Operating Condition of Luffing Jib with Superlift	Maximum rated capacity	t	198
	Boom length	m	36~84
	Jib length	m	27(33)~87
	Fully extended boom + fully extended luffing jib	m	84+87
	Superlift mast length	m	30
FJ Operating Condition of Fixed Jib	Maximum rated capacity	t	108
	Boom length	m	87+9
Speed data	Rope speed of main (auxiliary) winch	m/min	0~140
	Rope speed of main luffing	m/min	0~56×2
	Rope speed of auxiliary luffing	m/min	0~101
	Rope speed of superlift luffing	m/min	0~111
	Swing speed	rpm	0~1.5
Engine	Travel Speed	km/h	0~1.2/0~0.4 (two gearshifts)
	Output power	Kw	400/2000r
Weight	Crane weight (basic boom)	t	330
	Rear counterweight + central counterweight + superlift counterweight	t	135(155)40+250
	Maximum transport weight of single piece	t	55
Average ground pressure (basic boom)		MPa	0.173

Note: The wire rope speed of main/auxiliary winch, main/auxiliary luffing winch, superlift winch refer to the speed at the outermost layer.



TRANSPORT DIMENSIONS

Basic machine	×1
Length	12.2m
Width	3.1m
Height	3.3m
Weight	55t
Crawler Assembly	×2
Length	10.6m
Width	2.2m
Height	1.5m
Weight	34t
Boom Tip (250t boom head)	×1
Length	3m
Width	2.3m
Height	1.2m
Weight	2.3t
Boom Tip (400t boom head)	×1
Length	3m
Width	2.3m
Height	1.3m
Weight	4t
Transitional Section	×1
Length	6.2m
Width	2.8m
Height	2.4m
Weight	3.7t
Mixed Boom Transitional Section	×1
Length	4.3m
Width	2.8m
Height	2.4m
Weight	2.4t
Boom Base	×1
Length	11.8m
Width	2.8m
Height	2.4m
Weight (including Aux. luffing winch)	13t

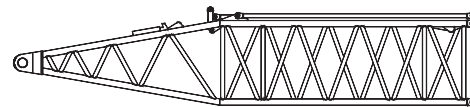
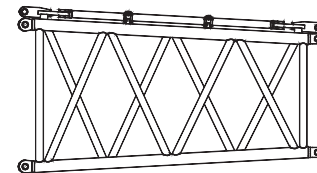
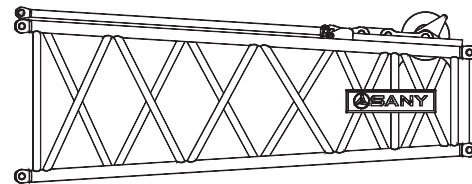
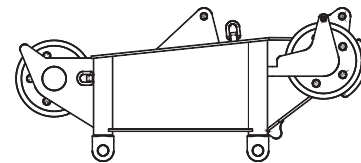
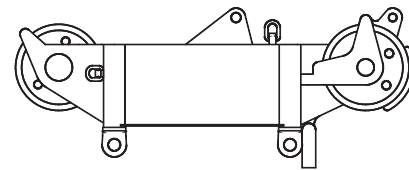
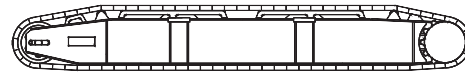
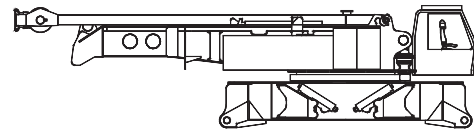

TRANSPORT DIMENSIONS

3m Boom Insert	×1
Length	3.2m
Width	2.8m
Height	2.4m
Weight	2t
6m Boom Insert	×2
Length	6.2m
Width	2.8m
Height	2.4m
Weight	3.4t
12mA Boom Insert	×5
Length	12.2m
Width	2.8m
Height	2.4m
Weight	6.1t
12mB Boom Insert	×1
Length	12.2m
Width	2.8m
Height	2.4m
Weight	6.1t
12mC Boom Insert	×1
Length	12.2m
Width	2.8m
Height	2.4m
Weight	6.1t
Jib Tip	×1
Length	11m
Width	2.3m
Height	1.9m
Weight	4t
Assembling Unit of Jib Base, Jib Luffing Mast, Jib Fixed Mast and Connecting Section	×1
Length	18m
Width	2.3m
Height	3.3m
Weight	15.5t

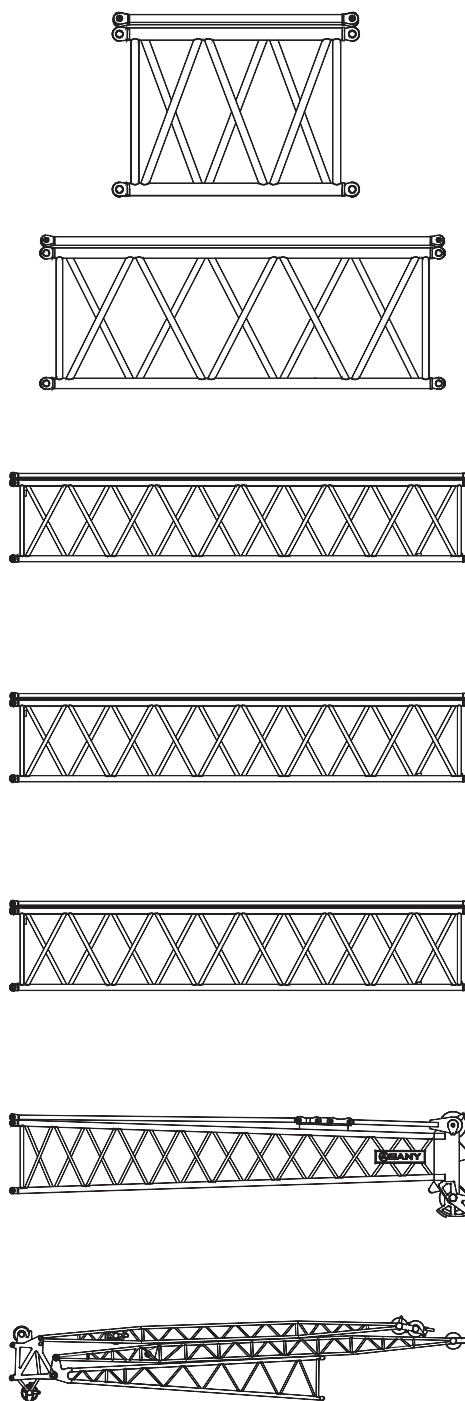



TRANSPORT DIMENSIONS

6m Jib Insert	×1
Length	6.2m
Width	2.3m
Height	1.9m
Weight	1.8t
12m Jib Insert	×5
Length	12.2m
Width	2.3m
Height	1.9m
Weight	3.2t
Extension Boom	×1
Length	2.7m
Width	1.2m
Height	1.4m
Weight	0.5t
Trolley	×1
Length	2.6m
Width	1.8m
Height	1.1m
Weight	1t
Superlift Mast Tip	×1
Length	12.5m
Width	2.1m
Height	2m
Weight	5.9t
Superlift Mast Base	×1
Length	12.3m
Width	2.7m
Height	2.2m
Weight (including superlift luffing winch and counterweight hoisting cylinder)	15t
Superlift Mast 6m Boom Insert	×1
Length	6.2m
Width	2.6m
Height	2m
Weight	2t

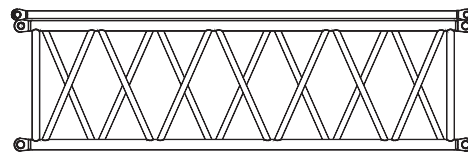
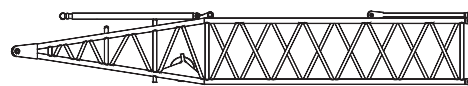
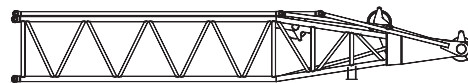
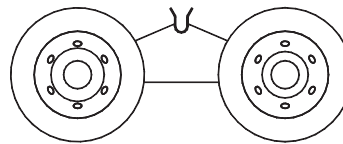
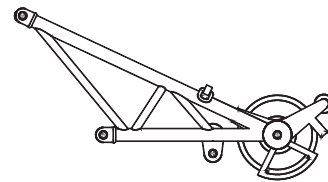
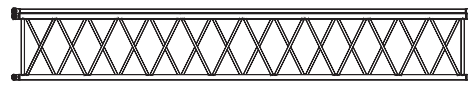
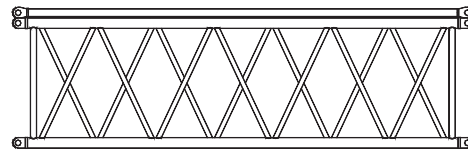

TRANSPORT DIMENSIONS

12m Light-duty Boom I	×1
Length	12.2m
Width	2.8m
Height	2.4m
Weight	5.2t
12m Light-duty Boom II	×1
Length	12.2m
Width	2.8m
Height	2.4m
Weight	4.8t
Light-duty Transitional Section	×1
Length	6.2m
Width	2.8m
Height	2.4m
Weight	3.2t
Fixed Jib Pack	×1
Length	11.2m
Width	2.3m
Height	2.8m
Weight	5.2t
Central Counterweight Tray	×2
Length	4.35m
Width	2.99m
Height	1.05m
Weight	2.25t
Rear Counterweight Frame	×1
Length	7.6m
Width	2.5m
Height	0.25m
Weight	15t
10t Counterweight Block	×40
Length	2.5m
Width	1.6m
Height	0.46m
Weight	10t

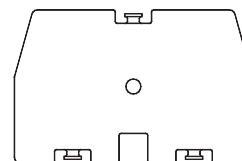
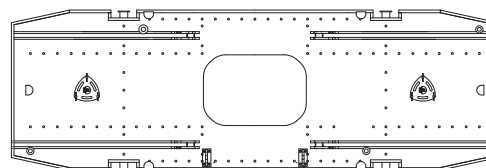
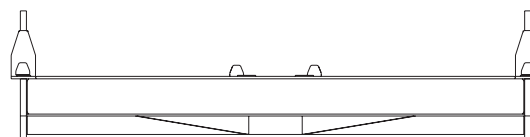
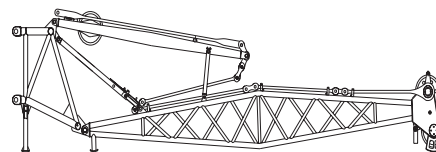
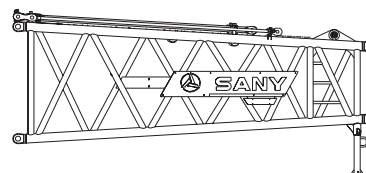
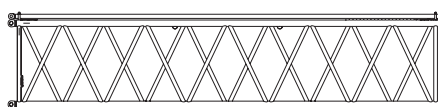
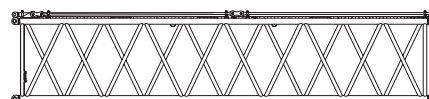



TRANSPORT DIMENSIONS

Superlift Counterweight Frame	×1
Length	6.4m
Width	2.2m
Height	0.76m
Weight	5.7t
15t Lifting Hook	×1
Length	1.2m
Width	0.46m
Height	0.46m
Weight	0.77t
35t Lifting Hook	×1
Length	1.8m
Width	0.77m
Height	0.54m
Weight	1.5t
50t Lifting Hook	×1
Length	2.11m
Width	0.77m
Height	0.6m
Weight	2.43t
100t Lifting Hook	×1
Length	1.8m
Width	0.77m
Height	0.54m
Weight	2.8t
400t Lifting Hook	×1
Length	3.4m
Width	1.3m
Height	1.8m
Weight	7t
Note: It can be disassembled into two 200t lifting hooks	
Hoisting Winch Mechanism	×2
Length	1.6m
Width	1.2m
Height	1.2m
Weight	4.8t

Notes: 1.The transport dimensions of the parts are marked on schematic diagrams, but not drawn by scale; the dimensions indicated are the design values excluding package.

2.The weight is the design value and there may be tiny difference due to the manufacturing calibration.

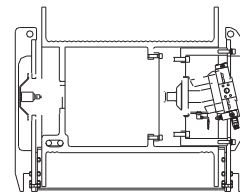
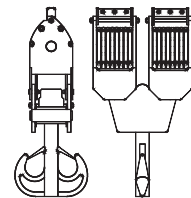
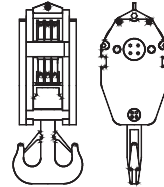
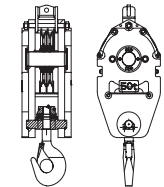
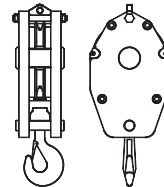
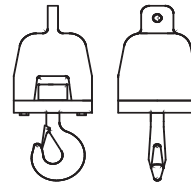
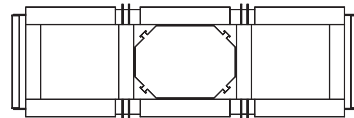



SCC4000E

Upperworks	15
Lowerworks	16
Operation Device	17
Safety Devices	18
Assembly/Disassembly Diagram	19

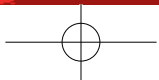

UPPERWORKS

1) Engine

Eight-cylinder and water-cooled engine (BF8M1015CP) of a famous manufacturer runs at the rated power 400kW and the rated speed of 2000rpm.

2) Electrical System

RC controller, imported encoder and load moment indicator of famous brands are used. CAN bus is used for transmitting data and improving the reliability of system.

3) Hydraulic System

The main elements of hydraulic system are imported. The closed circuit is used for hoisting, traveling, and slewing; the starting, stopping and reversing are stable with no shock, fast response to operation, little heat generated, and long life; the luffing system is an open system.

4) Swing Mechanism

- Swing part: With two motor reducer drives; the swing is smooth at the maximum swing speed of 1.5r/min in a stepless way it has the function of neutral free slipping and can provide 360° swing.
- Swing ring: Triple-row roller swing ring.

5) Winch Mechanism

The polyline drum ensures the smooth multi-layer winding, and the reducer is built in, boasting low noise, high efficiency, long life, and convenient oil replacement. Imported wire ropes are used with a single-rope tension of 15t.

NO.1 Main winch

Drum diameter	700mm
Length of wire rope	800m

NO.2 Auxiliary winch

Drum diameter	700mm
Length of wire rope	800m

NO.3 Main luffing

Drum diameter	650mm
Length of wire rope	550m

NO.4 Auxiliary luffing

Drum diameter	676mm
Length of wire rope	750m

NO.5 Superlift luffing

Drum diameter	676mm
Length of wire rope	930m



LOWERWORKS

1) Traveling Drive

The traveling system has two gearshifts, and it provides a strong traction force, capable of realizing 70% steering and traveling under load; each travel reducer is independently driven, and may flexibly perform forward, back or spot turning steering.

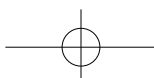
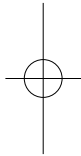
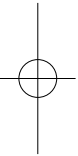



OPERATION DEVICE

All the operation devices adopt imported high-strength tubes and high-strength steel plates. Pulley materials: the pulleys on boom lever are all the cast iron pulleys, and those on hooks are all nodular cast iron pulleys.

1) Lifting Hook

- 15t lifting hook
- 35t lifting hook
- 50t lifting hook(Optional)
- 100t lifting hook
- 400t lifting hook (which can be disassembled into the 200t lifting hooks)

2) Operating Conditions

- H: Boom operating condition
- HD: Operating conditions of boom + superlift mast
- HDB: Operating conditions of boom + superlift mast + superlift counterweight
- LJ: Operating condition of luffing jib
- LJD: Operating condition of luffing jib + superlift mast
- LJDB: Operating condition of luffing jib + superlift mast + superlift counterweight
- HJ: Operating condition of mixed boom
- HJD: Operating conditions of mixed boom + superlift mast
- HJDB: Operating conditions of mixed boom + superlift mast + superlift counterweight
- H_L: Operating condition of light-duty boom
- SF_L: Operating condition of fixed jib

SAFETY DEVICES

1) Load Moment Indicator

An imported load moment indicator is used, and it forms a network with other controllers via CAN bus to realize safe and reliable control. It may automatically detect the weight hoisted by the crane and the angle of boom, and displays the rated loading capacity and actual load, operating radius and the height of boom head.

2) Over Roll-out/Over-hoist Limit Device for Main and Auxiliary Hoisting

3) Boom Limit Device

When the elevation angle of boom is over 87° and lowering angle below 30° ; and the elevation angle of jib is over 77° and lowering angle below 25° , the corresponding limit switch actuates to make the buzzer give alarms. Meanwhile, the manipulation is limited and the boom stops automatically. The protection function is automatically controlled by the load moment indicator.

4) Boom Back-stop Device

The all-round back-stop system of boom, superlift and jib prevents the boom from tipping over due to the vibration and sudden unloading during operation.

5) Winch Mechanism Brake

All winch brakes are spring-loaded normal-engaged disk brakes, which provide a big braking force and are safe, reliable, free of maintenance, and durable.

6) CCTV Monitoring System

It can monitor the winding condition of wire ropes on each winch mechanism, status of superlift counterweight, and the situation surrounding equipment.

7) Pharos

8) Self-diagnosis System

It can eliminate the fault conveniently according to the fault codes.

9) Black Box

It can record the operating situation of the driver and operation parameters of equipment, and this is favorable to analysis of accident cause.

10) Anemometer

It is installed on the top of the boom to real-time monitor the wind speed .

11) Gradiometer

The electronic gradiometer displays the inclining angle of crane on the monitor and guarantees the safe operation of crane.

12) Lightning Protection Device

With the lightning protection device, the crane can be safety grounded before the thunderstorm, so as to protect the electric equipment from lightning stroke.

13) Hook Clamp

Each kind of lifting hook is equipped with a clamp plate to prevent the wire rope from falling off.

14) Swing and Traveling Alarm

15) Manipulation Release Lever

When the manipulation release lever is retracted, all the manipulation handles are not functioning to avoid misoperation of handles in getting on/off the crane.

16) Engine Power Limit Load Adjustment and Stalling Protection

The controller monitors the engine power to prevent the engine from stalling.



ASSEMBLY/DISASSEMBLY DIAGRAM

Self-assembly diagram of crawler frame:

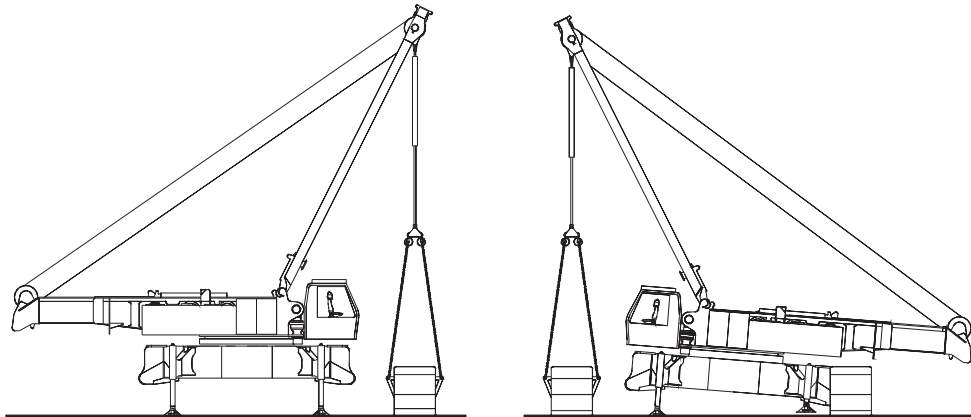

Assembly diagram of boom:

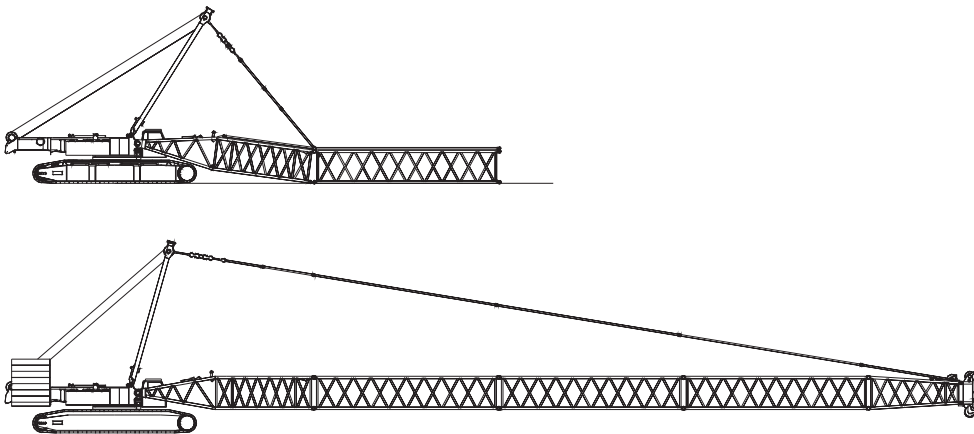



ASSEMBLY/DISASSEMBLY DIAGRAM

Assembly diagram of luffing jib:

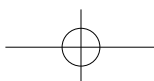
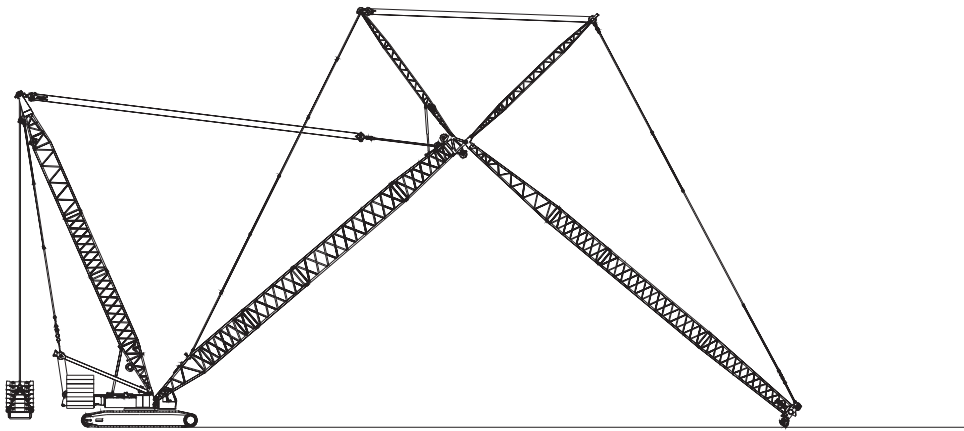
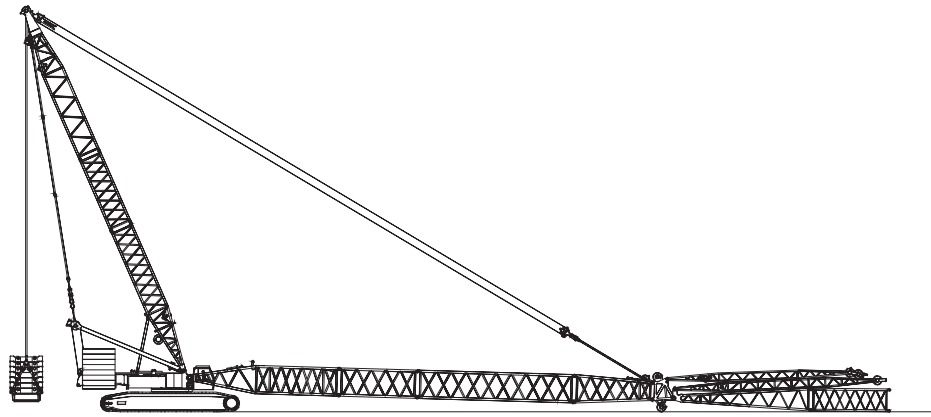

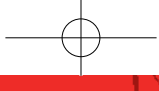

SCC4000E

22	Operating Condition Combination
23	H Operating Condition
27	HDB Operating Condition
30	LJ Operating Condition
36	LJDB Operating Condition
46	HJ Operating Condition
50	HJDB Operating Condition
53	H ₂ Operating Condition
57	SF ₁ Operating Condition

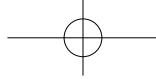

OPERATING CONDITION COMBINATION

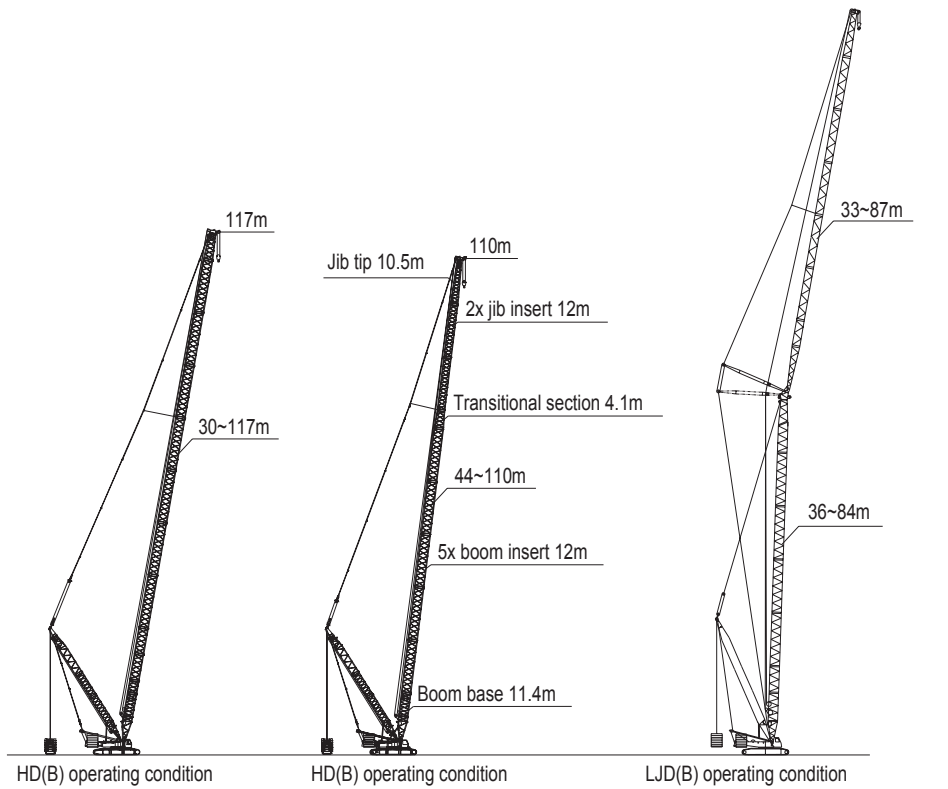
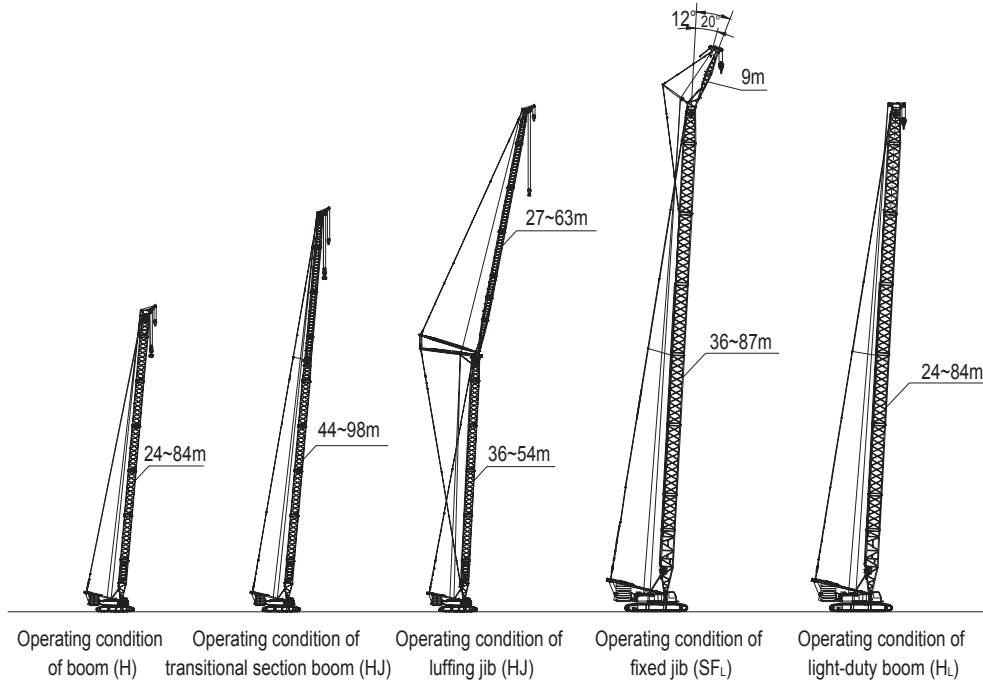

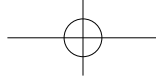

H OPERATING CONDITION

Boom length	Insert		
	m	6 m	12mA
24	1	—	—
30	—	1	—
36	1	1	—
42	—	2	—
48	1	2	—
54	—	3	—
60	1	3	—
66	—	4	—
72	1	4	—
78	—	5	—
84*	1	4	1

Attention: When the 78m boom and rear counterweight is 135t is raised under the operating condition, the side lifting outrigger must be used for raising the arm sideward; otherwise the crane will be at the risk of tipping over!

* When the boom is 84m, it must be used with mid-point suspension cable, otherwise, it exist the danger of arm-fracture.

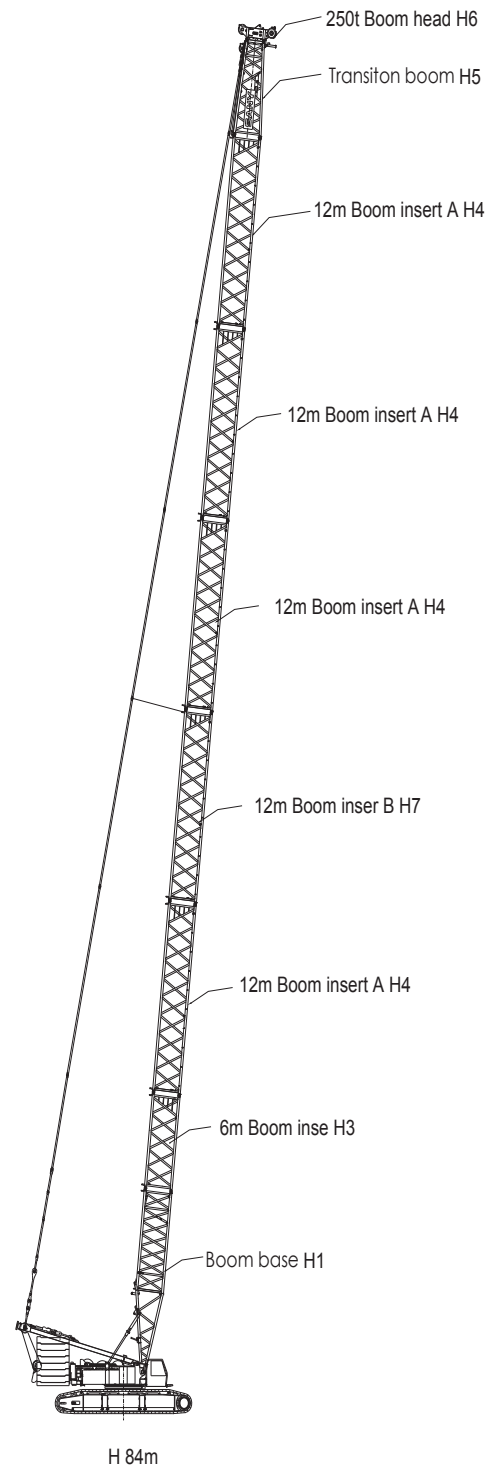

H OPERATION CONDITION RANGE DIAGRAM

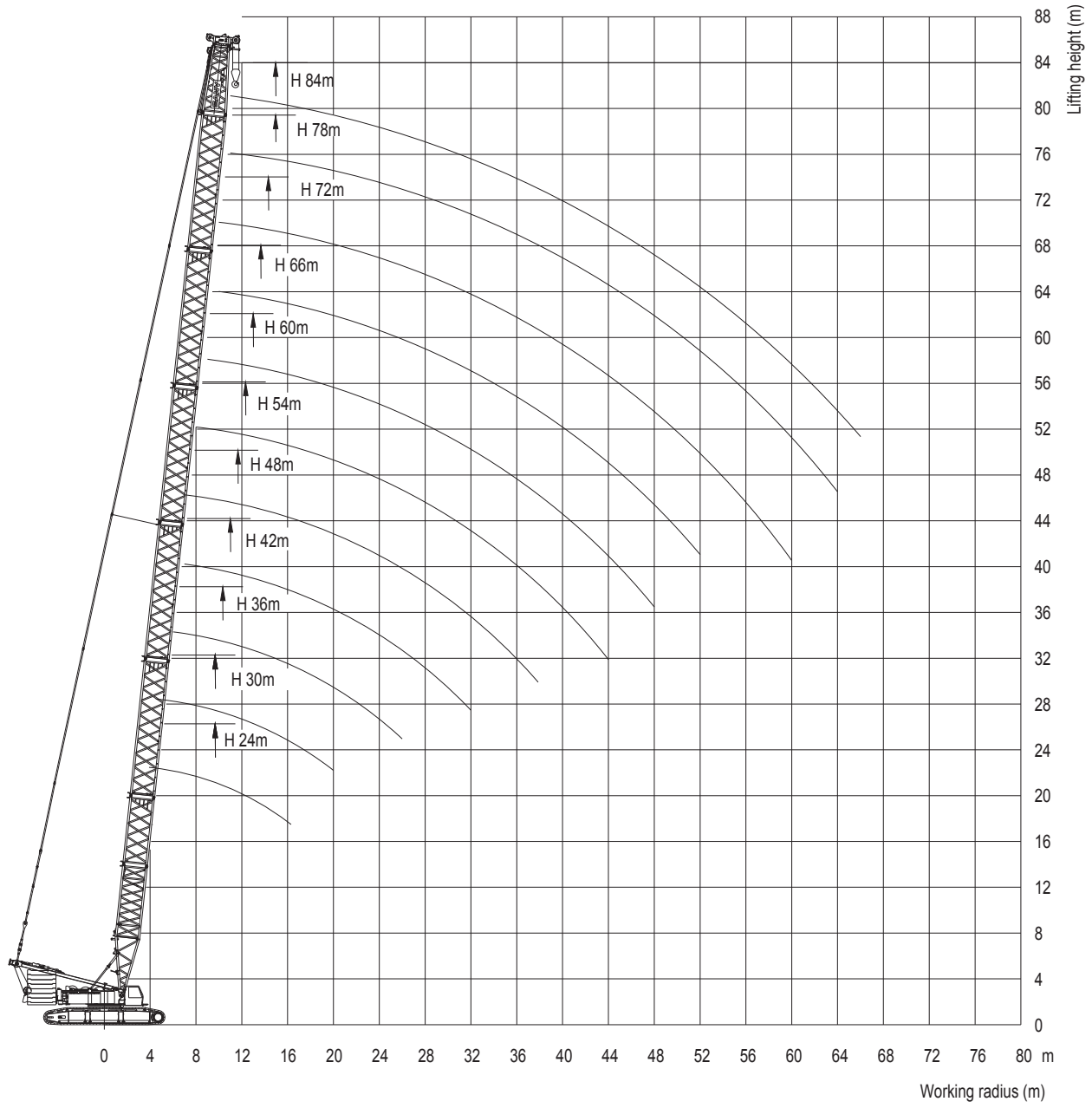

Working range curve

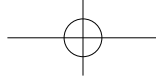

H OPERATION CONDITION LOAD CHARTS

SCC4000E Crawler Crane - Load Chart of Boom (H) Operating Condition

Boom 24m—84m Rear counterweight 135t Central counterweight 40t

Unit: (t)

Boom length(m) Radius(m)	24	30	36	42	48	54	60	66	72	78	84	Boom length(m) Radius(m)
4.5	400											4.5
5	380											5
5.5	358											5.5
6	331	326										6
6.5	309	301										6.5
7	288	280	278	272								7
8	259	251	247	242	235							8
9	232	227	221	216	207	194						9
10	209	203	198	193	185	173	162	155				10
11	189	184	179	174	166	157	147	140	132			11
12	168	165	162	156	147	139	131	127	122	114	110	12
14	140	139	137	131	128	120	113	108	104	98	95	14
16	116	114	112	109	108	103	98	94	90	86	82	16
18	98	97	95	93	92	90	86	83	77	75	72	18
20	86	83	82	81	81	79	75	75	67	65	63	20
22		74	72	71	71	70	66	65	59	57	54	22
24		64	63	62	62	61	59	57	52	51	49	24
26		59	57	56	55	54	52	51	46	45	43	26
28			51	50	49	48	47	45	41	40	38	28
30			46	45	44	43	42	41	37	36	35	30
32			42	40	41	39	38	37	33	32	30	32
34				37	37	36	34	33	29	28	27	34
36				34	33	32	31	30	27	25	24	36
38				32	31	30	29	27	24	23	22	38
40					29	27	26	24	21	20	19	40
44					24	23	22	20	17	16	15	44
48						20	18	16	14	13	13	48
52							15	14	10	10	10	52
56								11	8	8	7	56
60								9	6	6	6	60
64									4	4	4	64
68											4	68
Wind velocity (m/s))	14.3			12.8				11.8			Wind velocity (m/s))	

Attention: When the 78m boom is raised under the operating condition, the side lifting outrigger must be used for raising the boom sideward; otherwise the crane will be at the risk of tipping over!

* When the boom is 84m, it must be used with mid-point suspension cable, otherwise, it exists the danger of arm-fracture.

Description: 1. The actual lifting capacity must be obtained by deducting the weight of lifting hook, hoisting tools, and wire rope wound around the lifting hook and boom head from the rated lifting capacity in the table.

2. The rated load indicated in the table is the weight hoisted slowly and stably on a level and hard soil ground.

H OPERATION CONDITION LOAD CHARTS

SCC4000E Crawler Crane - Load Chart of Boom (H) Operating Condition

Boom 24m—84m Rear counterweight 155t Central counterweight 40t Unit: (t)

Boom length(m) Radius(m)	24	30	36	42	48	54	60	66	72	78	84	Boom length(m) Radius(m)	
7	292	276	280	270								7	
8	259	254	250	244	237							8	
9	232	228	225	217	214	205						9	
10	210	209	205	198	195	186	174	157				10	
11	191	189	187	181	177	169	159	150	134			11	
12	172	170	167	163	158	151	143	135	128	120	110	12	
14	152	150	146	139	136	131	124	118	111	108	101	14	
16	127	129	128	123	120	114	108	105	99	99	93	16	
18	109	109	108	107	105	102	94	92	87	87	85	18	
20	95	94	93	91	91	90	81	82	77	75	76	20	
22		80	80	80	79	79	71	72	69	68	69	22	
24		72	73	71	71	69	65	63	62	62	62	24	
26		65	66	63	63	62	59	57	56	55	54	26	
28			61	58	57	54	52	51	51	50	48	28	
30			54	52	51	50	49	46	46	45	43	30	
32			49	47	46	45	42	44	42	40	39	32	
34				43	41	40	38	40	38	36	36	34	
36				40	38	36	35	36	35	33	32	36	
38				36	35	34	32	33	31	30	28	38	
40					32	31	31	30	28	27	25	40	
44					29	27	26	25	24	22	21	44	
48						24	23	21	20	18	18	48	
52							19	18	16	14	14	52	
56								15	14	12	11	56	
60								13	11	9	9	60	
64									9	7	6	64	
68										6	5	68	
72											4	72	
Wind velocity (m/s)	14.3				12.8				11.8				Wind velocity (m/s)

Description: 1. The actual lifting capacity must be obtained by deducting the weight of lifting hook, hoisting tools, and wire rope wound around the lifting hook and boom head from the rated lifting capacity in the table.
 2. The rated load indicated in the table is the weight hoisted slowly and stably on a level and hard soil ground.



HDB OPERATING CONDITION

Boom length m	Insert				
	3m	6 m	12mA	12mB	12mC
30	—	—	1	—	—
36	—	1	1	—	—
42	—	—	1	1	—
48	—	1	2	—	—
54	—	—	2	1	—
60	—	1	3	—	—
66	—	—	4	—	—
72	—	1	3	1	—
78	—	—	5	—	—
84	—	1	4	1	—
90	—	—	5	—	1
96*	—	1	5	1	—
102*	—	—	5	1	1
108*	—	1	5	1	1
114*	—	2	5	1	1
117*	1	2	5	1	1

** Indicates that when the boom is 96m, 102m, 108m, 114m, and 117m long, the mid-point suspension cable must be used; otherwise the boom is at the risk of fracture;

Attention: When the 66m boom is raised under the operating condition, the side lifting outrigger must be used for raising the arm from the side; otherwise the crane will be at the risk of tipping over!

When the 72~117m boom is raised under the operating condition, the superlift counterweight must be used; otherwise the crane will be at the risk of tipping over!

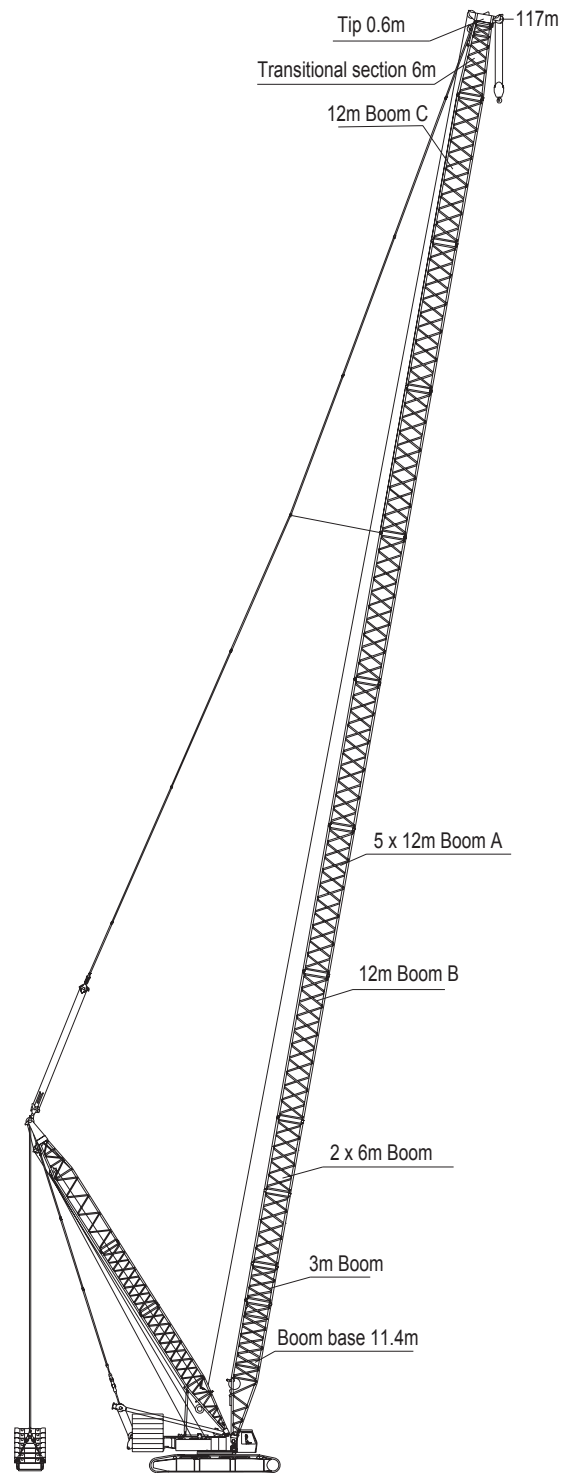

HDB RANGE DIAGRAM

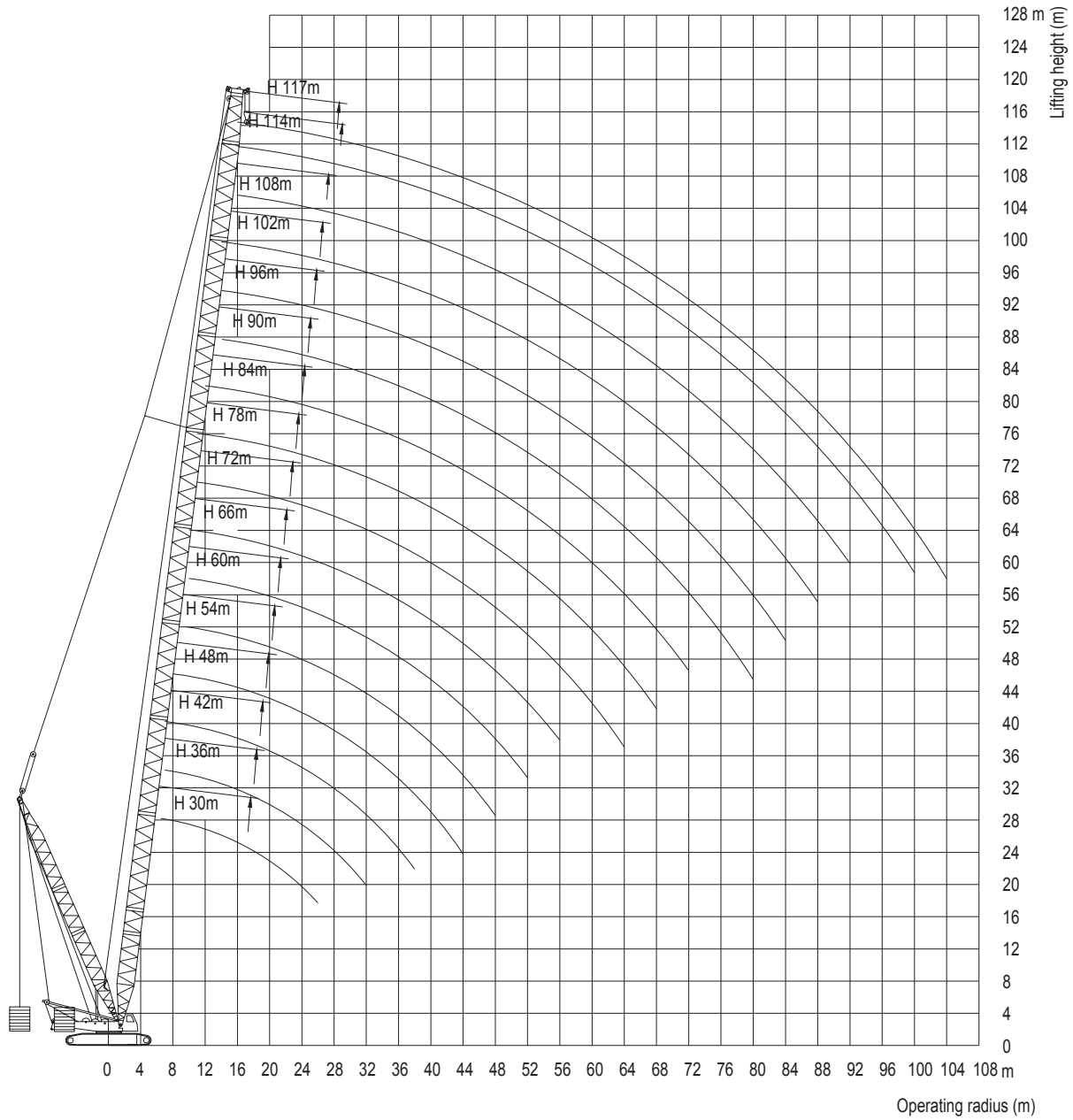

Operating Range Curve of Lifting Height

LOAD CHARTS OF HDB OPERATING CONDITION

SCC4000E Crawler Crane - HDB Load Chart

Boom 30m-117m Superlift mast 30m Rear counterweight135t Superlift counterweight 0-250t Central counterweight 40t

																	Unit: (t)
Boom length(m) Radius(m)	30	36	42	48	54	60	66	72	78	84	90	96	102	108	114	117	Boom length(m) Radius(m)
6.5	400.0																6.5
7	400.0	400.0	400.0														7
8	395.2	388.5	378.0	367.5													8
9	379.6	378.0	372.8	367.5	344.4												9
10	374.4	372.8	367.5	367.5	332.9	299.3	262.2										10
11	364.0	364.4	364.4	364.4	322.4	298.2	261.1	228.8	198.0								11
12	358.8	358.1	356.0	347.6	310.8	298.2	261.1	228.8	196.9	166.4							12
14	329.7	327.6	322.4	316.1	291.9	280.4	258.8	227.7	194.7	164.3	139.7	123.9	105.0				14
16	304.7	299.3	295.1	288.8	270.9	262.5	243.8	226.4	192.5	163.3	137.6	123.9	105.0	90.3	77.7	68.7	16
18	280.8	276.2	272.0	266.7	251.0	243.6	233.2	217.6	191.4	161.2	135.5	122.9	105.0	89.3	76.7	68.7	18
20	261.0	255.2	251.0	247.8	232.1	225.8	218.4	208.7	185.0	159.1	133.4	121.8	104.0	89.3	76.7	68.7	20
22	237.1	236.3	234.2	231.0	216.3	211.1	204.6	196.2	178.1	156.0	129.2	120.8	102.9	88.2	75.6	68.0	22
24	213.2	214.2	212.1	213.2	202.7	198.5	191.1	187.5	169.6	151.1	125.0	119.7	100.8	86.1	75.6	67.7	24
26	197.6	197.4	194.3	193.2	190.1	187.6	180.6	176.0	162.2	147.0	121.9	118.7	98.7	84.0	74.6	67.7	26
28		183.8	181.7	182.7	179.6	177.0	169.1	166.3	152.6	140.8	118.7	117.6	96.6	82.3	73.5	67.7	28
30		171.2	170.1	168.0	168.0	167.5	159.6	155.2	145.2	133.5	115.5	115.5	94.5	80.2	72.5	66.7	30
32		157.5	157.5	157.5	154.4	156.2	151.2	148.7	138.9	126.7	111.3	113.4	92.4	78.4	70.4	65.7	32
34			150.2	148.1	143.9	145.5	142.8	140.2	131.4	120.5	109.2	109.2	89.3	76.7	68.3	64.6	34
36			140.7	137.6	136.5	136.7	135.5	132.5	125.1	115.4	106.5	106.1	87.2	75.6	66.2	63.6	36
38			131.3	131.3	129.2	128.3	123.9	122.9	118.7	110.2	102.2	101.9	86.1	73.5	65.1	62.6	38
40				125.0	120.8	120.3	115.5	115.5	111.3	104.6	99.0	97.7	84.4	68.6	62.2	60.2	40
44				112.4	105.0	107.1	107.1	102.8	96.6	95.3	92.7	90.3	79.6	66.5	58.0	56.8	44
48					97.7	96.6	95.6	94.3	91.4	88.0	86.3	83.0	74.2	62.2	52.8	52.5	48
52						88.2	86.1	85.9	81.9	77.9	77.7	76.7	66.2	56.2	49.8	49.8	52
56							79.8	77.7	73.5	71.0	70.3	69.3	60.8	52.5	46.6	46.6	56
60								70.4	67.2	65.0	64.5	62.0	56.4	49.5	42.6	43.1	60
64								64.9	63.0	59.2	58.8	57.8	50.1	45.3	40.5	40.5	64
68									57.8	55.1	54.3	53.6	43.9	41.7	38.5	37.5	68
72										51.5	50.1	49.4	40.5	39.0	36.0	35.0	72
76											47.4	44.6	38.0	37.0	34.0	32.0	76
80											44.7	42.0	35.5	34.5	32.5	30.0	80
84												39.4	33.5	32.0	31.0	28.0	84
88													32.0	30.0	28.5	25.0	88
92														28.0	26.0	22.0	92
96															25.0	19.0	96
100																22.0	100
104																13.0	104
Wind velocity (m/s)	14.3		12.8			11.1						9					Wind velocity (m/s)

! Attention: When the 66m boom is raised under the operating condition, the side lifting outrigger must be used for raising the boom from the side; otherwise the crane will be at the risk of tipping over!

When the 72~117m boom is raised under the operating condition, the superlift counterweight must be used; otherwise the crane will be at the risk of tipping over!

Description: 1. The actual lifting capacity must be obtained by deducting the weight of lifting hook, hoisting tools, and wire rope wound around the lifting hook and boom head from the rated lifting capacity in the table.

2. The rated load indicated in the table is the weight hoisted slowly and stably on a level and hard soil ground.

LJ (DB) OPERATING CONDITION

Jib length m	Insert		Boom length(m)
	6 m	12 m	
27	1	—	36~54(LJ) 36~84(LJDB)
33	—	1	
39	1	1	
45	—	2	
51	1	2	
57	—	3	
63	1	3	
69*	—	4	
75*	1	4	
81*	—	5	
87*	1	5	

The length of jib under the LJ operating condition: 27m~63m

The length of jib under the LJDB operating condition: 27m or 33m~87m

* Indicates when the mid-point suspension cable must be used for the 69m~87m jibs!

Attention: The 54m boom + jib of any length, and 135t rear counterweight must be raised with the side lifting outrigger under the LJ operating condition. Otherwise the crane will be at the risk of tipping over!

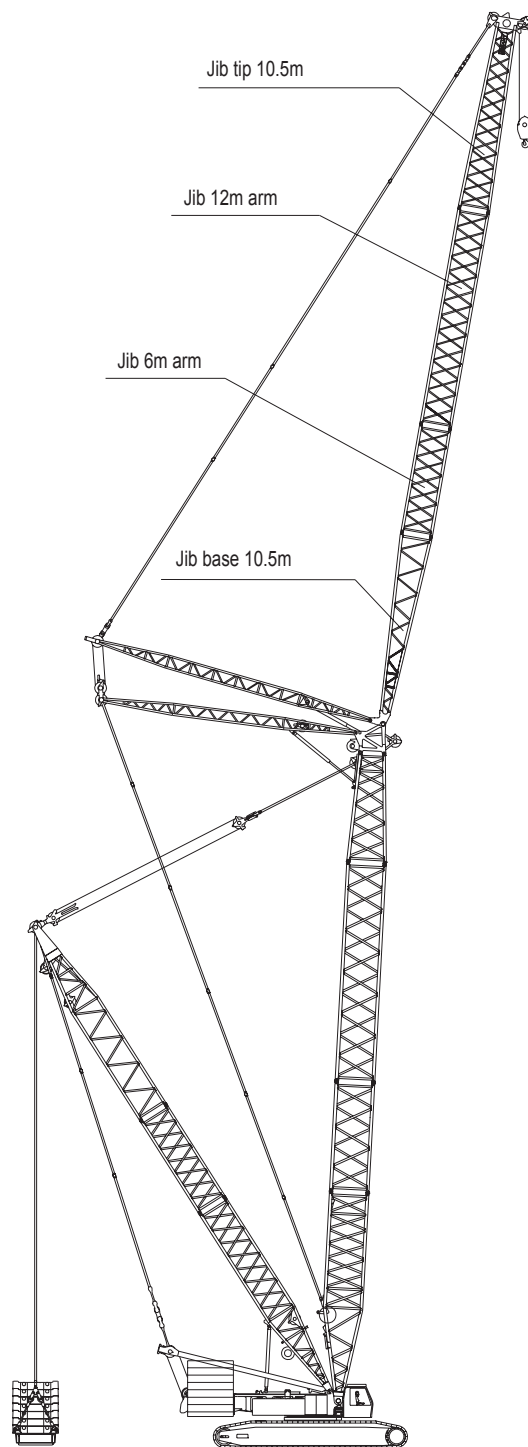



LUFFING JIB RANGE DIAGRAM

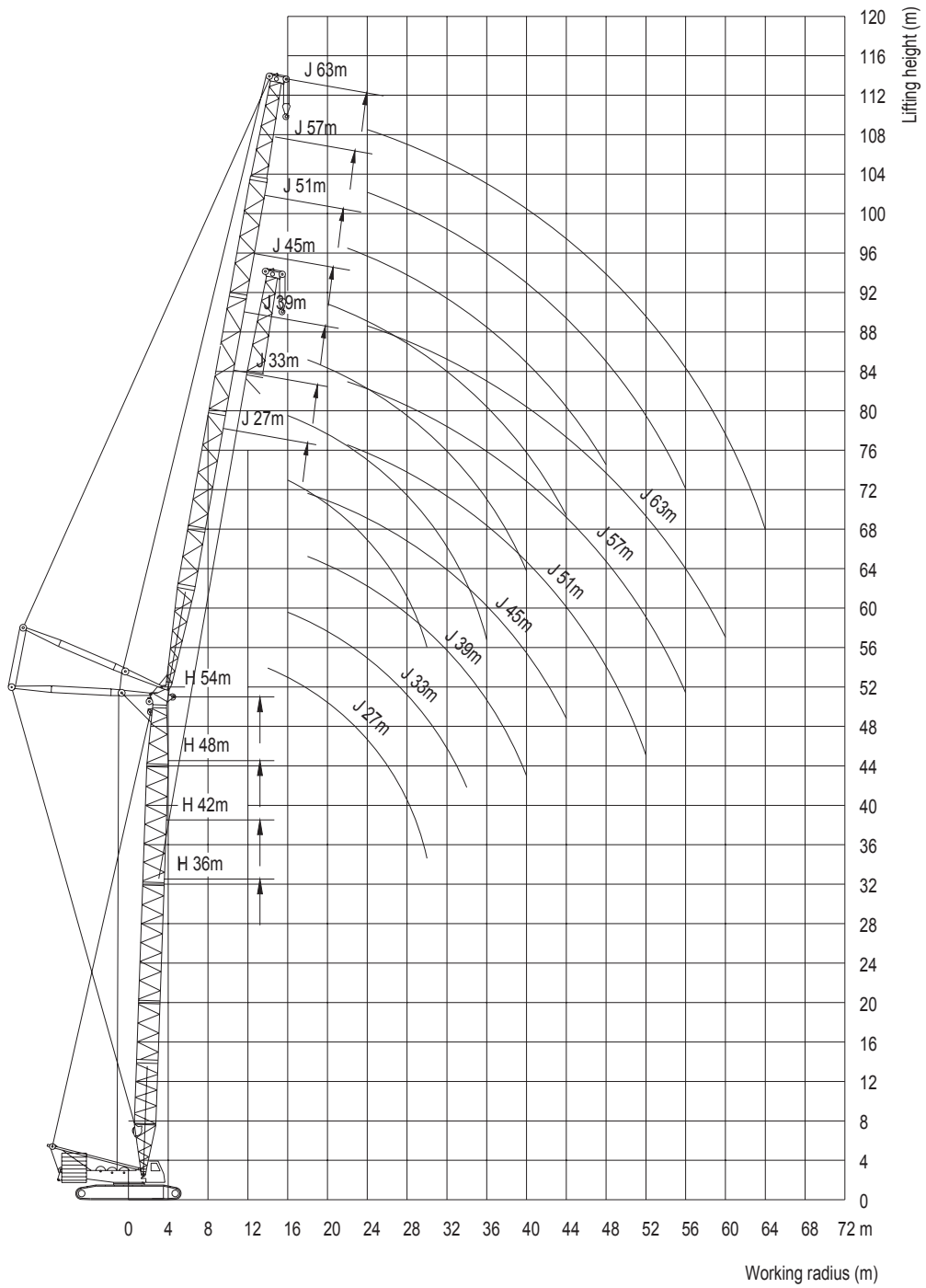

Working range curve

LUFFING JIB LOAD CHARTS

SCC4000E Crawler Crane - Load Chart of Luffing Jib (LJ) Operating Condition Boom 87° , 36m—54m Rear counterweight 155t Central counterweight 40t Unit: (t)

Boom 36m

Boom length(m) Radius(m)	27	33	39	45	51	57	63	Boom length(m) Radius(m)
14	126.0							14
16	110.3	108.2						16
18	99.8	96.6	93.6	90.0				18
20	89.3	87.2	83.2	82.2				20
22	80.9	79.8	75.9	74.9	70.7	67.0		22
24	74.6	72.5	69.7	69.7	64.5	61.6	57.2	24
26	68.8	67.2	64.5	63.4	59.7	55.6	54.0	26
28	62.5	62.0	59.3	58.2	55.1	51.4	51.0	28
30	56.7	57.8	55.1	54.1	52.0	47.6	47.5	30
32		53.0	52.0	51.0	48.4	44.9	44.3	32
34		48.8	47.8	47.3	45.2	42.6	41.5	34
36			44.7	43.7	42.1	39.9	39.0	36
38			41.6	41.1	39.5	37.3	36.5	38
40			38.5	38.5	37.4	35.0	34.5	40
44				33.8	32.8	32.0	30.8	44
48					29.1	28.2	26.4	48
52					25.5	24.0	23.1	52
56						21.3	20.9	56
60							18.7	60
Wind velocity (m/s)	12.8	11.1						Wind velocity (m/s)

- Description: 1. The actual lifting capacity must be obtained by deducting the weight of lifting hook, hoisting tools, and wire rope wound around the lifting hook and boom head from the rated lifting capacity in the table.
2. The rated load indicated in the table is the weight hoisted slowly and stably on a level and hard soil ground.

LUFFING JIB LOAD CHARTS

SCC4000E Crawler Crane - Load Chart of Luffing Jib (LJ) Operating Condition

Boom 87° , 36m—54m Rear counterweight 155t Central counterweight 40t Unit: (t)

Boom 42m

Boom length(m) Radius(m)	27	33	39	45	51	57	63	Boom length(m) Radius(m)
14	122.9							14
16	108.2	108.0						16
18	96.6	97.2	94.0					18
20	86.6	86.4	84.2	81.0				20
22	78.8	77.8	76.7	73.4	68.0	65.0		22
24	72.5	71.3	70.2	68.0	62.6	61.6	57.2	24
26	67.2	65.9	64.8	62.6	58.3	57.2	53.8	26
28	62.0	59.9	58.8	58.3	54.0	52.9	52.3	28
30	56.7	55.7	54.6	54.0	49.7	49.7	49.2	30
32		51.5	50.9	50.8	46.4	46.2	46.6	32
34		47.8	47.3	47.5	44.3	43.2	43.7	34
36			44.1	44.3	41.8	40.0	39.9	36
38			41.0	41.6	39.6	37.8	36.9	38
40			37.0	38.9	37.4	36.3	34.5	40
44				34.0	33.0	33.0	32.4	44
48					29.7	28.8	28.4	48
52					25.9	25.3	25.1	52
56						23.1	22.5	56
60							19.8	60
Wind velocity (m/s)	11.1					9		Wind velocity (m/s)

- Description: 1. The actual lifting capacity must be obtained by deducting the weight of lifting hook, hoisting tools, and wire rope wound around the lifting hook and boom head from the rated lifting capacity in the table.
2. The rated load indicated in the table is the weight hoisted slowly and stably on a level and hard soil ground.

LUFFING JIB LOAD CHARTS

SCC4000E Crawler Crane - Load Chart of Luffing Jib (LJ) Operating Condition Boom 87° , 36m—54m Rear counterweight 155t Central counterweight 40t Unit: (t)

Boom 48m

Boom length(m) Radius(m)	27	33	39	45	51	57	63	Boom length(m) Radius(m)
14	111.0							14
16	102.9	100.8						16
18	92.4	91.4	89.1					18
20	84.0	81.9	82.5	77.1				20
22	75.6	73.5	73.4	70.7	67.1			22
24	69.3	68.3	67.0	65.0	60.5	59.4	52.9	24
26	64.1	63.0	61.6	60.0	58.0	56.0	52.4	26
28	59.9	58.8	55.7	54.6	54.0	51.7	50.2	28
30	55.7	54.6	51.5	50.9	51.0	48.4	47.9	30
32		50.4	48.3	47.7	47.1	45.1	44.6	32
34		47.3	45.2	44.5	43.0	41.8	41.6	34
36			42.0	41.9	39.7	39.6	39.1	36
38			39.9	39.8	36.7	37.4	36.2	38
40			37.8	37.1	36.0	35.2	33.9	40
44				33.0	29.7	31.4	30.5	44
48					26.2	28.1	27.1	48
52					23.8	24.8	23.7	52
56						22.0	20.7	56
60							18.4	60
64							16.8	64
Wind velocity (m/s)	11.1			9			Wind velocity (m/s)	

Description: 1. The actual lifting capacity must be obtained by deducting the weight of lifting hook, hoisting tools, and wire rope wound around the lifting hook and boom head from the rated lifting capacity in the table.
 2. The rated load indicated in the table is the weight hoisted slowly and stably on a level and hard soil ground.

LUFFING JIB LOAD CHARTS

SCC4000E Crawler Crane - Load Chart of Luffing Jib (LJ) Operating Condition Boom 87° , 36m—54m Rear counterweight 155t Central counterweight 40t Unit: (t)

Boom 54m

Boom length(m) Radius(m)	27	33	39	45	51	57	63	Boom length(m) Radius(m)
16	94.0	86.1						16
18	88.4	82.0	74.5					18
20	80.9	75.6	70.7	66.3				20
22	73.5	69.3	66.3	63.4	59.3			22
24	67.2	64.1	61.2	59.9	56.7	51.5		24
26	62.0	58.8	57.7	55.7	53.5	50.2	44.2	26
28	57.8	54.6	53.8	51.9	50.2	47.9	43.4	28
30	52.5	50.9	50.4	48.8	46.9	45.6	42.3	30
32		47.8	47.3	45.6	43.7	43.5	40.7	32
34		45.2	44.1	42.4	41.4	41.2	38.5	34
36		41.5	41.0	40.1	39.1	38.9	36.3	36
38			38.3	38.2	36.9	36.7	34.1	38
40			35.7	35.5	34.6	33.9	31.9	40
44				31.3	31.4	30.8	28.6	44
48					28.1	27.5	25.5	48
52					24.8	24.2	22.6	52
56						21.6	19.6	56
60							17.3	60
64							15.5	64
Wind velocity (m/s)	11.1			9				Wind velocity (m/s)

- Description: 1. The actual lifting capacity must be obtained by deducting the weight of lifting hook, hoisting tools, and wire rope wound around the lifting hook and boom head from the rated lifting capacity in the table.
 2. The rated load indicated in the table is the weight hoisted slowly and stably on a level and hard soil ground.

OPERATING RANGE DIAGRAM OF LJDB OPERATING CONDITION

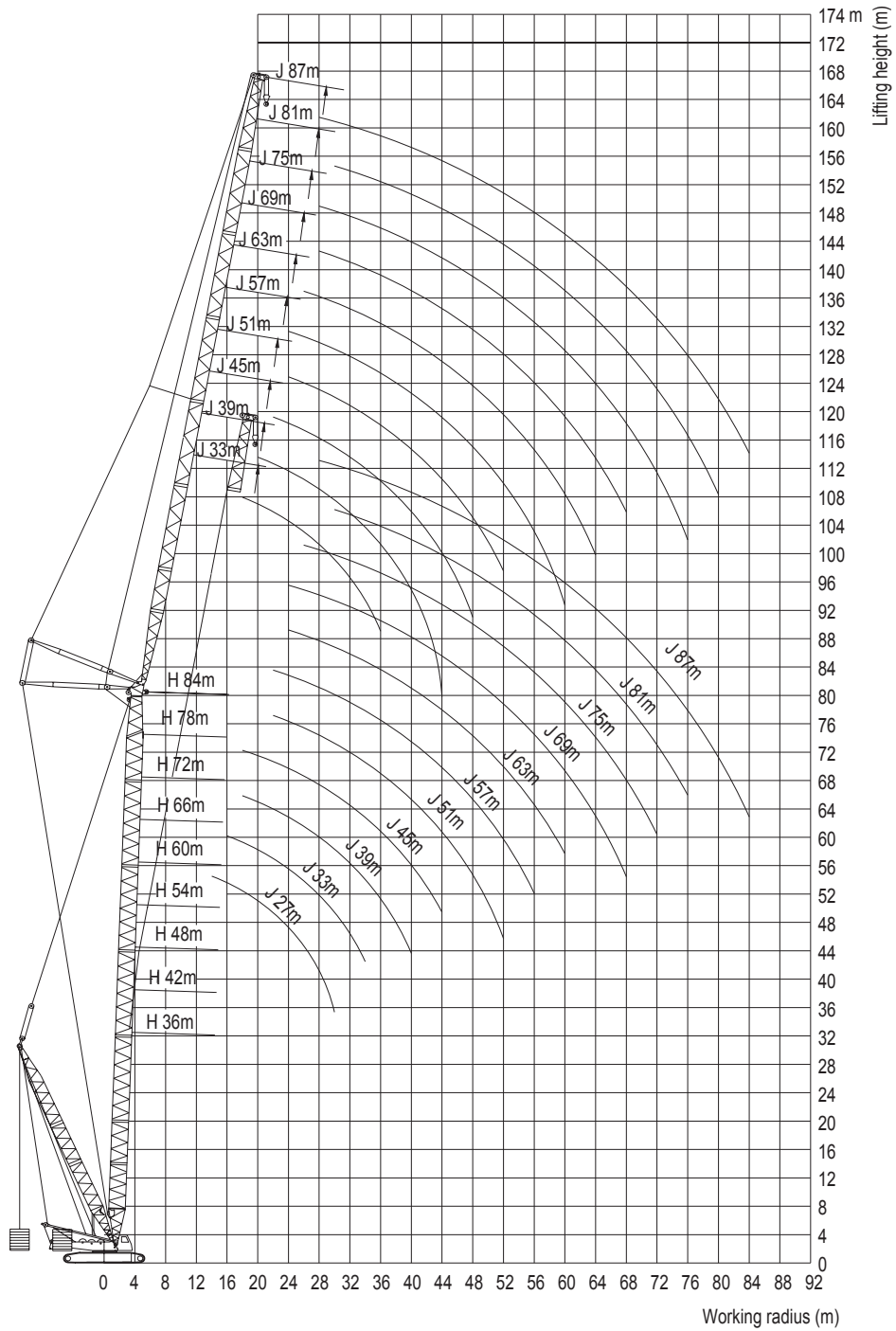

Working range curve



LOAD CHARTS OF LJDB OPERATING CONDITION

SCC4000E Crawler Crane - LJDB Load Chart

Boom 87° 36m-84m Superlift mast 30m Jib 27m or 33m-87m Superlift counterweight 0~250t
Radius 11~15m Rear counterweight 135t Central counterweight 40t

Unit: (t)

Boom 36m

Boom length(m) Radius(m)	27	33	39	45	51	57	63	69	75	81	87	Boom length(m) Radius(m)
14	198.0											14
16	184.8	158.4										16
18	173.8	151.8	136.9	123.6								18
20	160.9	145.2	132.2	119.2								20
22	147.0	139.7	126.6	114.7	102.0	77.0						22
24	138.6	130.7	122.0	110.2	95.5	75.9	66.7	59.4				24
26	126.0	120.8	117.5	106.7	93.2	74.8	64.4	57.2	51.2			26
28	114.5	113.4	108.0	102.6	88.0	73.7	62.2	55.1	50.6			28
30	104.0	102.9	100.8	98.0	85.8	72.6	61.0	53.0	50.0	42.0	34.5	30
32		94.5	94.5	93.8	81.4	71.5	58.9	52.5	49.5	41.4	33.9	32
34		88.2	87.2	86.4	79.2	70.4	55.6	52.5	48.9	41.4	33.4	34
36			81.9	80.9	75.9	66.2	53.6	51.5	48.3	40.8	32.2	36
38			76.7	74.6	69.3	64.1	51.5	49.4	47.5	40.3	32.2	38
40			71.4	70.4	66.2	62.0	49.4	48.3	46.9	39.7	31.1	40
44				63.0	62.0	58.8	45.2	44.1	42.5	38.6	29.7	44
48					54.6	52.5	42.0	41.5	41.0	35.7	28.6	48
52					47.3	46.2	38.9	38.3	37.8	34.7	26.8	52
56						44.1	35.7	35.7	35.7	33.6	26.3	56
60							33.6	33.6	33.1	32.6	25.6	60
64								31.5	31.0	31.0	25.0	64
68								30.5	30.5	27.8	24.2	68
72									28.4	25.7	23.4	72
76										23.6	23.1	76
80											22.3	80
84											20.5	84
Wind velocity (m/s)	12.8	11.1										Wind velocity (m/s)

LOAD CHARTS OF LJDB OPERATING CONDITION

SCC4000E Crawler Crane - LJDB Load Chart

Boom 87° 36m-84m Superlift mast 30m Jib 27m or 33m-87m Superlift counterweight 0~250t
 Radius 11~15m Rear counterweight 135t Central counterweight 40t

Unit: (t)

Boom 42m

Boom length(m) Radius(m)	27	33	39	45	51	57	63	69	75	81	87	Boom length(m) Radius(m)
14	174.9											14
16	168.3	146.3										16
18	159.5	139.7	128.8									18
20	149.0	135.3	122.1	105.6								20
22	137.0	129.8	116.6	104.2	88.0	73.7						22
24	128.1	122.0	111.1	100.1	85.8	72.6	63.3					24
26	120.8	115.6	105.8	96.8	83.6	70.4	62.1	54.5				26
28	113.4	110.2	98.7	93.5	82.5	68.0	61.0	53.9	43.5			28
30	105.0	103.7	94.5	86.1	80.3	65.1	59.8	51.8	41.0	38.6	31.5	30
32		100.4	91.4	81.9	76.7	63.0	58.7	51.3	40.4	37.4	31.1	32
34		95.0	88.2	77.7	74.5	62.0	57.5	49.4	39.4	36.9	30.6	34
36			85.1	73.5	73.4	60.9	55.2	48.8	39.4	36.9	29.9	36
38			81.9	68.3	68.0	58.8	52.9	47.8	38.9	36.3	29.3	38
40			76.7	63.0	63.7	57.8	50.6	46.2	38.3	35.3	28.8	40
44				56.7	58.3	54.6	45.1	43.1	37.3	33.6	27.6	44
48					52.9	51.5	41.0	39.9	36.2	32.6	26.7	48
52					49.7	47.3	36.7	35.7	35.2	32.6	25.9	52
56						42.0	34.7	34.7	33.6	32.0	24.2	56
60							33.6	33.1	31.5	29.4	22.8	60
64								30.5	28.9	27.3	21.5	64
68								29.4	26.8	25.2	21.0	68
72									24.7	23.3	20.0	72
76										22.1	18.9	76
80										21.0	17.3	80
84											16.3	84
Wind velocity (m/s)	11.1					9					Wind velocity (m/s)	

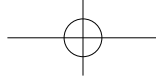

LOAD CHARTS OF LJDB OPERATING CONDITION

SCC4000E Crawler Crane - LJDB Load Chart

Boom 87° 36m-84m Superlift mast 30m Jib 27m or 33m-87m Superlift counterweight 0~250t
Radius 11~15m Rear counterweight 135t Central counterweight 40t

Unit: (t)

Boom 48m

Boom length(m) Radius(m)	27	33	39	45	51	57	63	69	75	81	87	Boom length(m) Radius(m)
14	154.0											14
16	148.5	129.8										16
18	143.0	125.4	115.0									18
20	129.2	121.0	107.5	95.7								20
22	123.9	114.5	103.4	95.2	82.5							22
24	117.6	106.1	100.1	91.3	82.0	71.5	61.5					24
26	111.3	102.9	95.0	89.1	80.3	70.4	59.8	52.3				26
28	105.0	98.7	88.2	85.8	79.2	68.0	58.7	51.7	44.0			28
30	99.8	93.5	84.0	80.3	77.0	65.1	58.7	50.1	42.7	36.9	28.2	30
32		89.3	81.9	75.6	73.4	63.0	56.9	49.1	41.7	35.3	27.6	32
34		86.1	78.8	74.6	71.3	62.0	56.4	47.3	41.2	34.2	27.0	34
36			75.6	72.5	69.1	58.8	54.6	46.2	39.9	33.6	26.6	36
38			72.5	68.3	67.0	56.7	52.5	45.2	39.4	32.8	25.4	38
40			68.3	65.1	63.7	54.6	50.4	44.1	38.9	32.3	24.9	40
44				59.9	59.4	52.5	46.8	42.5	37.8	31.7	23.7	44
48					54.0	49.4	42.1	39.9	37.3	30.8	23.3	48
52					44.3	43.1	38.9	37.8	35.7	30.1	22.4	52
56						36.8	34.7	34.7	33.6	29.4	20.9	56
60							32.6	32.6	31.5	27.8	19.6	60
64								30.5	30.5	27.3	18.9	64
68									28.9	25.7	18.1	68
72										24.2	17.7	72
76											21.0	76
80											18.9	80
84												84
Wind velocity (m/s)	9											Wind velocity (m/s)

LOAD CHARTS OF LJDB OPERATING CONDITION

SCC4000E Crawler Crane - LJDB Load Chart

Boom 87° 36m-84m Superlift mast 30m Jib 27m or 33m-87m Superlift counterweight 0~250t
 Radius 11~15m Rear counterweight 135t Central counterweight 40t

Unit: (t)

Boom 54m

Boom length(m) Radius(m)	27	33	39	45	51	57	63	69	75	81	87	Boom length(m) Radius(m)
16	140.3	116.6										16
18	132.3	112.2	103.5									18
20	124.3	108.9	96.3	84.7								20
22	117.6	105.6	93.5	83.6	74.8							22
24	111.0	99.4	90.2	80.7	72.6	64.9						24
26	101.9	94.0	86.9	78.1	71.5	63.8	56.4	47.3				26
28	97.7	90.7	80.9	75.6	69.3	61.6	54.6	46.2	40.2			28
30	96.6	87.5	76.7	70.4	68.2	58.9	52.9	44.3	38.5	33.7	27.3	30
32		84.2	74.6	68.3	64.8	56.7	51.8	43.7	37.5	32.5	26.7	32
34		82.1	72.5	66.2	62.6	54.6	49.7	42.0	36.8	31.9	26.3	34
36		81.0	70.4	64.1	61.6	53.6	48.6	41.0	36.2	31.6	25.9	36
38			68.3	63.0	59.4	52.5	46.9	40.4	35.7	31.1	25.3	38
40			66.2	62.0	58.3	50.4	45.8	39.9	35.2	30.0	24.7	40
44				59.9	55.1	47.3	42.9	37.8	34.7	28.4	24.2	44
48				56.7	50.8	45.2	39.6	36.8	33.6	27.6	23.0	48
52					48.6	43.1	37.3	34.7	32.6	26.8	22.1	52
56						41.0	34.6	32.0	29.9	26.3	20.4	56
60							31.5	29.4	27.8	25.2	18.7	60
64							29.4	27.8	26.3	23.1	17.9	64
68								26.3	24.2	21.0	16.8	68
72									22.1	20.0	15.8	72
76										18.9	14.7	76
80										16.3	13.7	80
84											13.1	84

Wind velocity
(m/s)

9

Wind velocity
(m/s)



LOAD CHARTS OF LJDB OPERATING CONDITION

SCC4000E Crawler Crane - LJDB Load Chart

Boom 87° 36m-84m Superlift mast 30m Jib 27m or 33m-87m Superlift counterweight 0~250t
Radius 11~15m Rear counterweight 135t Central counterweight 40t

Unit: (t)

Boom 60m

Boom length(m) Radius(m)	27	33	39	45	51	57	63	69	75	81	87	Boom length(m) Radius(m)
16	121.9											16
18	116.2	101.2	94.3									18
20	111.6	96.8	88.5	79.2								20
22	107.2	93.5	84.7	78.4	68.2							22
24	101.7	88.6	82.5	74.8	66.0	59.4						24
26	91.4	85.3	79.2	72.6	63.8	58.3	51.8	45.1				26
28	88.2	82.1	73.5	70.4	62.7	56.2	50.6	44.6	38.0			28
30	87.2	77.8	70.4	65.1	60.5	53.6	49.5	43.2	35.7	32.0		30
32		75.6	68.3	63.0	57.2	51.5	48.3	42.7	35.2	31.0	27.0	32
34		74.5	67.2	60.9	56.2	50.4	47.2	41.0	34.7	30.5	26.5	34
36		72.4	66.2	59.9	54.0	48.8	46.0	39.9	34.1	29.7	26.0	36
38			65.1	58.8	52.9	47.8	44.9	38.9	33.6	29.3	25.5	38
40			63.0	55.7	50.8	46.2	42.6	37.8	33.0	28.8	25.0	40
44				51.5	48.6	44.1	40.3	36.2	32.0	26.8	24.4	44
48				47.3	47.5	42.5	36.3	34.1	30.8	26.0	23.6	48
52					45.4	40.4	34.0	32.6	29.4	24.7	22.4	52
56						37.8	31.9	30.5	27.3	23.6	21.6	56
60							28.9	28.4	25.7	22.1	19.8	60
64							26.8	26.3	24.2	21.5	18.1	64
68								24.7	22.1	20.0	17.1	68
72									21.0	18.4	16.2	72
76										16.8	14.7	76
80										15.8	13.7	80
84											12.6	84

Wind velocity
(m/s)

9

Wind velocity
(m/s)

LOAD CHARTS OF LJDB OPERATING CONDITIONV

SCC4000E Crawler Crane - LJDB Load Chart

Boom 87° 36m-84m Superlift mast 30m Jib 27m or 33m-87m Superlift counterweight 0~250t
 Radius 11~15m Rear counterweight 135t Central counterweight 40t

Unit: (t)

Boom 66m

Boom length(m) Radius(m)	27	33	39	45	51	57	63	69	75	81	87	Boom length(m) Radius(m)
16	106.7											16
18	102.3	92.4										18
20	97.2	89.1	82.8									20
22	92.4	86.9	77.0	69.3	65.6							22
24	89.3	83.2	73.4	68.2	64.4	55.2						24
26	85.1	79.9	70.4	66.0	60.5	54.1	44.9					26
28	81.9	75.6	66.0	64.9	58.3	52.0	44.3	39.1	34.5			28
30	79.8	71.4	62.0	62.7	56.1	50.4	43.7	38.5	33.9	28.2		30
32		68.3	60.9	59.4	54.0	49.0	43.1	38.0	33.4	27.6	20.7	32
34		67.2	60.4	56.7	51.5	47.0	42.6	36.8	32.8	27.0	20.1	34
36		66.2	59.9	54.6	50.9	44.6	41.2	35.3	31.6	26.5	19.7	36
38			58.8	53.6	49.4	44.1	38.9	34.1	30.8	25.9	19.3	38
40			57.8	52.5	48.3	43.1	37.8	33.6	30.2	25.3	18.9	40
44				49.4	46.2	42.0	35.1	32.1	28.6	24.4	18.4	44
48				48.3	44.1	38.9	34.0	31.0	26.7	23.1	17.9	48
52					43.1	36.8	32.4	29.9	24.2	22.0	17.0	52
56						35.7	29.4	28.4	23.1	20.9	16.6	56
60							27.3	25.9	22.1	19.8	15.7	60
64							25.2	23.6	21.0	18.7	14.9	64
68								22.1	20.0	17.6	13.5	68
72									17.9	16.0	12.6	72
76									16.3	15.0	11.6	76
80										13.6	10.8	80
84											9.5	84

Wind velocity (m/s)

9

Wind velocity (m/s)



LOAD CHARTS OF LJDB OPERATING CONDITION

SCC4000E Crawler Crane - LJDB Load Chart Boom 87° 36m-84m Superlift mast 30m Jib 27m or
33m-87m Superlift counterweight 0~250t
Radius 11~15m Rear counterweight 135t Central counterweight 40t

Unit: (t)

Boom 72m

Boom length(m) Radius(m)	27	33	39	45	51	57	63	69	75	81	87	Boom length(m) Radius(m)
16	95.7											16
18	91.3	83.6										18
20	87.5	81.4	73.6									20
22	81.9	79.2	68.8	63.8								22
24	78.8	77.0	66.6	61.6	58.1	49.5						24
26	75.6	72.4	65.5	59.4	56.4	48.3	40.3					26
28	74.6	68.3	63.8	58.3	53.8	46.9	39.7	35.1				28
30	73.5	66.2	58.8	57.2	51.7	45.4	39.1	34.5	30.5			30
32		64.1	56.7	54.0	49.7	44.8	38.5	33.9	29.9	26.0	20.2	32
34		63.0	55.7	51.5	46.7	42.1	38.0	33.4	29.3	25.5	19.8	34
36		62.0	54.6	49.4	45.7	39.9	36.7	32.2	28.8	25.1	19.3	36
38			52.5	47.8	44.6	38.9	34.6	31.6	28.2	24.6	18.7	38
40			52.0	46.2	43.1	37.8	33.5	31.1	27.6	24.2	18.4	40
44				44.1	41.5	35.7	32.4	29.2	26.5	23.5	17.8	44
48				42.0	39.9	34.1	30.2	26.3	24.2	22.4	17.3	48
52					39.4	33.1	29.2	25.2	22.6	20.9	16.2	52
56						31.5	26.8	23.8	21.5	19.3	15.7	56
60						29.4	25.2	22.7	20.4	17.9	15.0	60
64							23.1	20.8	19.2	16.6	14.0	64
68								19.5	17.9	15.7	12.8	68
72									16.8	14.5	12.1	72
76									15.3	13.3	11.3	76
80										12.1	10.5	80
84											9.8	84

Wind velocity
(m/s)

9

Wind velocity
(m/s)

LOAD CHARTS OF LJDB OPERATING CONDITIONV

SCC4000E Crawler Crane - LJDB Load Chart Boom 87° 36m-84m Superlift mast 30m Jib 27m or 33m-87m Superlift counterweight 0~250t
 Radius 11~15m Rear counterweight 135t Central counterweight 40t

Unit: (t)

Boom 78m

Boom length(m) Radius(m)	27	33	39	45	51	57	63	69	75	81	87	Boom length(m) Radius(m)
16	86.9											16
18	84.7	73.7										18
20	81.4	71.5	63.8									20
22	78.1	70.4	61.6	59.8								22
24	73.8	67.1	59.4	57.1	51.8	43.7						24
26	69.3	62.0	56.2	55.5	50.6	42.6	35.8					26
28	67.2	59.9	53.6	52.8	48.6	40.3	35.2	33.2				28
30	66.2	57.2	51.5	50.8	46.5	38.3	34.6	32.5	26.7			30
32	65.1	54.6	49.4	47.8	44.6	37.5	34.0	31.3	26.2	23.0		32
34		53.6	48.3	45.7	43.2	35.7	32.6	30.2	25.2	22.4	17.3	34
36		53.6	46.2	44.6	41.5	35.2	31.5	29.2	24.4	22.0	17.0	36
38		52.5	45.2	44.1	40.4	34.7	30.5	27.9	23.7	21.6	16.7	38
40			44.1	42.0	39.4	33.6	29.4	26.8	22.9	21.2	15.9	40
44			43.1	39.9	37.8	32.0	27.3	24.7	21.8	20.4	14.4	44
48				36.8	35.7	31.0	25.7	23.4	20.5	19.3	13.2	48
52					33.6	29.9	24.7	22.1	19.4	18.4	12.4	52
56						28.9	23.6	21.0	18.4	17.3	11.5	56
60							27.3	22.1	20.2	17.3	11.0	60
64								20.5	19.1	16.4	10.6	64
68									17.9	15.9	10.4	68
72										14.8	10.1	72
76										13.7	9.9	76
80											11.7	80
84												84

Wind velocity
(m/s)

9

Wind velocity
(m/s)



LOAD CHARTS OF LJDB OPERATING CONDITION V

SCC4000E Crawler Crane - LJDB Load Chart Boom 87° 36m-84m Superlift mast 30m Jib 27m or
33m-87m Superlift counterweight 0~250t
Radius 11~15m Rear counterweight 135t Central counterweight 40t

Unit: (t)

Boom 84m

Boom length(m) Radius(m)	33	39	45	51	57	63	69	75	81	87	Boom length(m) Radius(m)
18	66.0										18
20	63.8	57.2									20
22	62.7	55.0	51.8								22
24	60.5	53.9	49.5	45.4	41.4						24
26	55.7	52.8	48.3	44.3	40.3	34.1					26
28	53.6	48.3	45.1	42.9	38.1	33.6	29.9				28
30	51.5	46.2	44.0	40.3	36.3	32.5	29.2	24.8			30
32	49.4	44.6	40.4	38.5	35.2	31.9	28.5	24.2	20.7		32
34	48.3	43.6	38.9	35.7	32.6	29.9	27.9	22.7	20.2	14.5	34
36	47.8	43.1	37.8	34.7	31.5	28.9	26.5	22.3	19.8	14.0	36
38		41.0	36.8	33.6	30.5	27.8	26.0	21.7	19.0	13.7	38
40		39.9	35.7	32.6	29.4	27.3	24.6	21.2	18.1	13.2	40
44		38.9	33.6	30.5	27.3	25.7	22.7	20.7	16.4	12.8	44
48			31.5	28.9	26.3	24.2	21.3	19.5	15.2	12.1	48
52				26.8	25.2	23.1	20.1	18.4	14.4	11.5	52
56					24.2	22.1	18.9	16.8	13.8	10.7	56
60					23.6	21.0	18.1	15.6	13.2	9.8	60
64						20.0	17.4	14.7	12.7	9.0	64
68							16.8	14.5	12.2	8.1	68
72								14.2	12.1	7.1	72
76								13.7	11.7	6.7	76
80									11.5	6.2	80
84										5.8	84
Wind velocity (m/s)	9										Wind velocity (m/s)

- Description: 1. The actual lifting capacity must be obtained by deducting the weight of lifting hook, hoisting tools, and wire rope wound around the lifting hook and boom head from the rated lifting capacity in the table.
2. The rated load indicated in the table is the weight hoisted slowly and stably on a level and hard soil ground.

HJ OPERATING CONDITION

Boom length	Boom insert		Jib insert	
	6 m	12m	6m	12m
44	1	—	—	1
50	—	1	—	1
56	—	1	1	1
62	1	1	1	1
68*	—	2	1	1
74*	1	2	1	1
80*	—	3	1	1
86*	—	3	—	2
92*	1	3	—	2
98*	1	3	1	2

** Indicates that when the boom is 68m-98m, the mid-point suspension cable must be used; otherwise the arm support has risk of fracture;

! Attention: When the 98m arm is raised under the HJ operating condition, the side lifting outrigger must be used for raising arm sideward. Otherwise the crane will be at the risk of tipping over!

! When the 135t rear counterweight is raised under the HJ92m operating condition, the side lifting outrigger must be used for raising arm sideward. Otherwise the crane will be at the risk of tipping over!

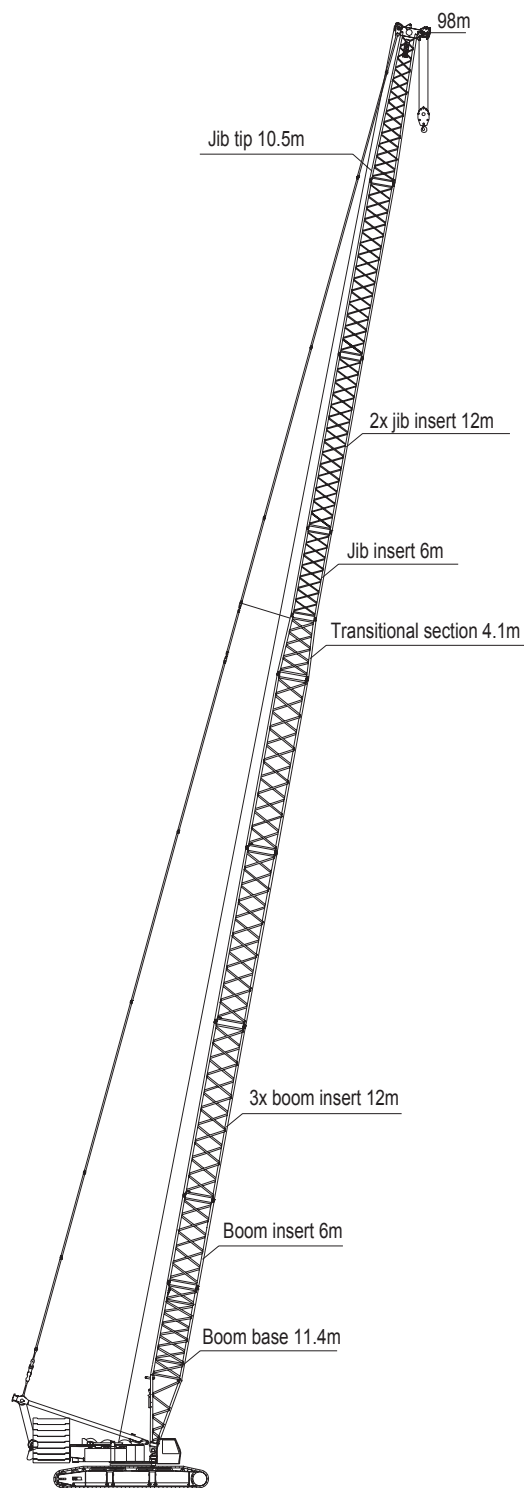



OPERATING RANGE DIAGRAM OF HJ OPERATING CONDITION

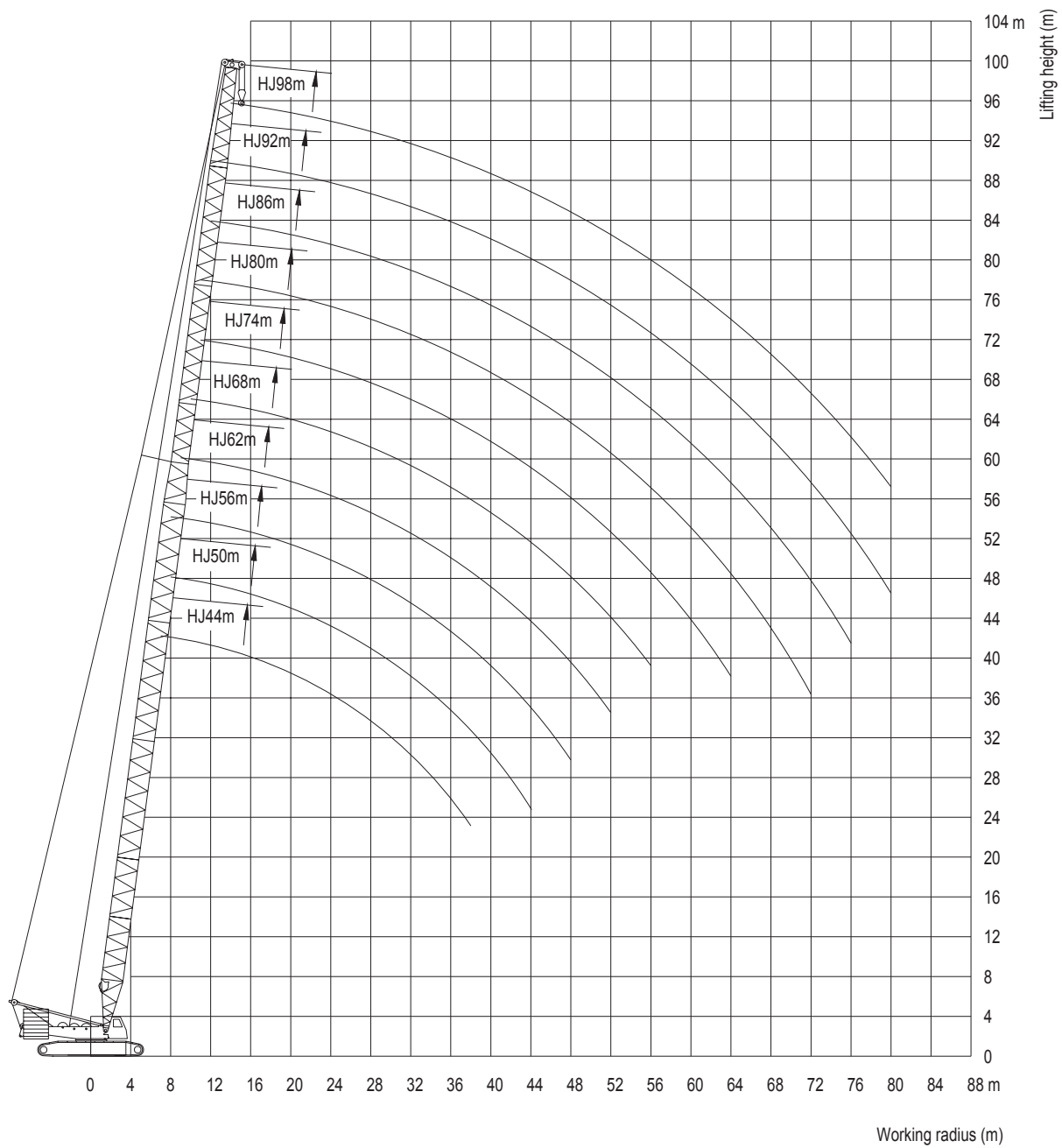

Working range curve

LOAD CHARTS OF HJ OPERATING CONDITION

SCC4000E Crawler Crane - HJ Load Chart

Mixed boom 44-98m Rear counterweight 135t Central counterweight 40t

											Unit: (t)
Boom length(m) Radius(m)	44	50	56	62	68	74	80	86	92	98	Boom length(m) Radius(m)
7	198										7
8	198	187	168								8
9	186	183	161	147							9
10	173	171	139	132	118						10
11	160	158	130	117	114	107	104				11
12	152	146	122	107	106	104	101	93	85		12
14	126	123	108	98	98	97	97	90	81	71	14
16	106	104	99	90	90	90	89	84	75	67	16
18	91	89	87	80	80	79	79	74	71	65	18
20	80	78	77	74	72	71	69	65	64	62	20
22	71	69	68	65	64	63	61	59	58	57	22
24	64	61	61	58	57	56	54	53	51	50	24
26	58	55	55	52	51	50	48	47	46	46	26
28	53	50	50	47	46	45	43	42	41	41	28
30	48	46	45	43	42	40	39	38	37	37	30
32	44	42	41	39	38	37	35	35	34	33	32
34	40	38	38	36	35	34	33	32	30	30	34
36	37	36	35	34	32	31	29	29	28	27	36
38	34	33	32	30	29	28	27	26	25	25	38
40		31	29	28	27	26	25	24	23	23	40
44		27	26	25	24	22	21	20	19	19	44
48			23	22	20	19	18	17	16	16	48
52				19	17	16	15	15	13	13	52
56					15	14	13	13	11	11	56
60						12	11	11	9	9	60
64						11	9	9	8	7	64
68							8	7	6	5	68
72							6	6	5	4	72
76								5	3		76
Wind velocity (m/s)	12.8					11.1					Wind velocity (m/s)

! Attention: When the 98m and 92m boom are raised under the operating condition, the side lifting outrigger must be used for raising arm sideward. Otherwise the crane will be at the risk of tipping over!

Description: 1. The actual lifting capacity must be obtained by deducting the weight of lifting hook, hoisting tools, and wire rope wound around the lifting hook and boom head from the rated lifting capacity in the table.

2. The rated load indicated in the table is the weight hoisted slowly and stably on a level and hard soil ground.



LOAD CHARTS OF HJ OPERATING CONDITION

SCC4000E Crawler Crane - HJ Load Chart

Mixed boom 44-98m Rear counterweight 155t Central counterweight 40t

											Unit: (t)
Boom length(m) Radius(m)	44	50	56	62	68	74	80	86	92	98	Boom length(m) Radius(m)
9	196	195									9
10	186	184	145								10
11	173	172	138	124	118	114					11
12	167	163	130	118	113	112	110				12
14	141	139	119	105	108	108	107	100	86	78	14
16	119	117	107	95	100	100	99	93	84	76	16
18	102	100	97	85	91	91	87	82	81	75	18
20	89	88	86	77	82	81	78	74	72	70	20
22	79	78	76	69	74	71	70	65	65	64	22
24	71	70	68	63	66	64	62	59	58	58	24
26	64	63	62	57	59	58	56	54	53	53	26
28	58	57	56	52	54	52	50	48	48	47	28
30	53	50	51	49	49	47	45	44	43	43	30
32	48	47	47	46	45	43	41	40	39	39	32
34	45	43	43	42	41	40	38	37	36	35	34
36	41	40	39	39	38	37	35	34	33	32	36
38	38	37	37	36	35	34	32	30	30	29	38
40		35	35	34	33	32	29	27	27	27	40
44		30	30	29	28	27	25	23	23	23	44
48			26	25	25	24	21	19	20	19	48
52				22	22	20	18	16	17	16	52
56					19	18	16	13	14	14	56
60						16	14	12	12	11	60
64						14	12	9	10	9	64
68							10	7	8	7	68
72							8	7	6	6	72
76								5	5	4	76
80									4	3	80
Wind velocity (m/s)	12.8				11.1						Wind velocity (m/s)

! Attention: When the 98m and 92m boom are raised under the operating condition, the side lifting outrigger must be used for raising arm sideward. Otherwise the crane will be at the risk of tipping over!

Description: 1. The actual lifting capacity must be obtained by deducting the weight of lifting hook, hoisting tools, and wire rope wound around the lifting hook and boom head from the rated lifting capacity in the table.

2. The rated load indicated in the table is the weight hoisted slowly and stably on a level and hard soil ground.

HJDB OPERATING CONDITION

Boom length	Boom insert		Jib insert	
	6 m	12m	6m	12m
44	1	1	-	-
50	-	2	-	-
56	-	2	1	-
62	-	2	-	1
68	1	2	-	1
74	1	2	1	1
80*	-	3	1	2
86*	-	3	-	2
92*	1	3	-	2
98*	-	4	-	2
104*	1	4	-	2
110*	-	5	-	2

*Indicates that when the boom is 80m-110m, the mid-point suspension cable must be used; otherwise the arm support has risk of fracture;

Attention: When the 80~110m arm support is raised under the operating condition, the superlift counterweight must be used; otherwise the crane is at the risk of tipping over!

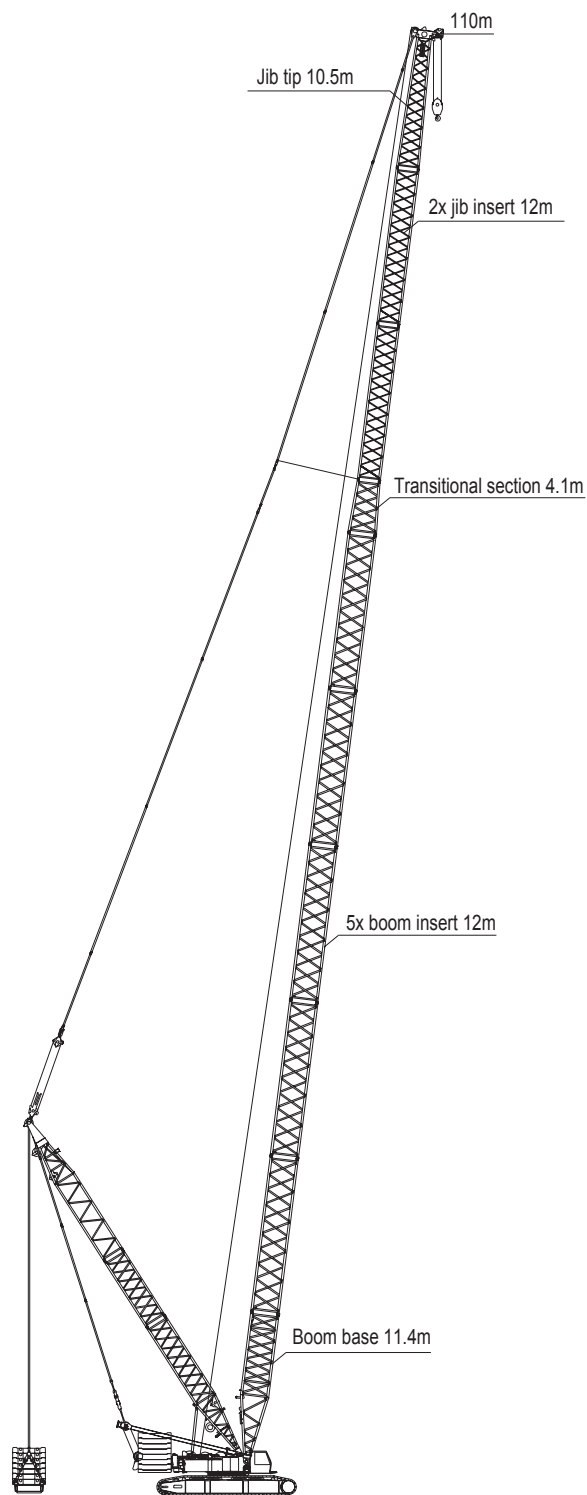



OPERATING RANGE DIAGRAM OF HJDB OPERATING CONDITION

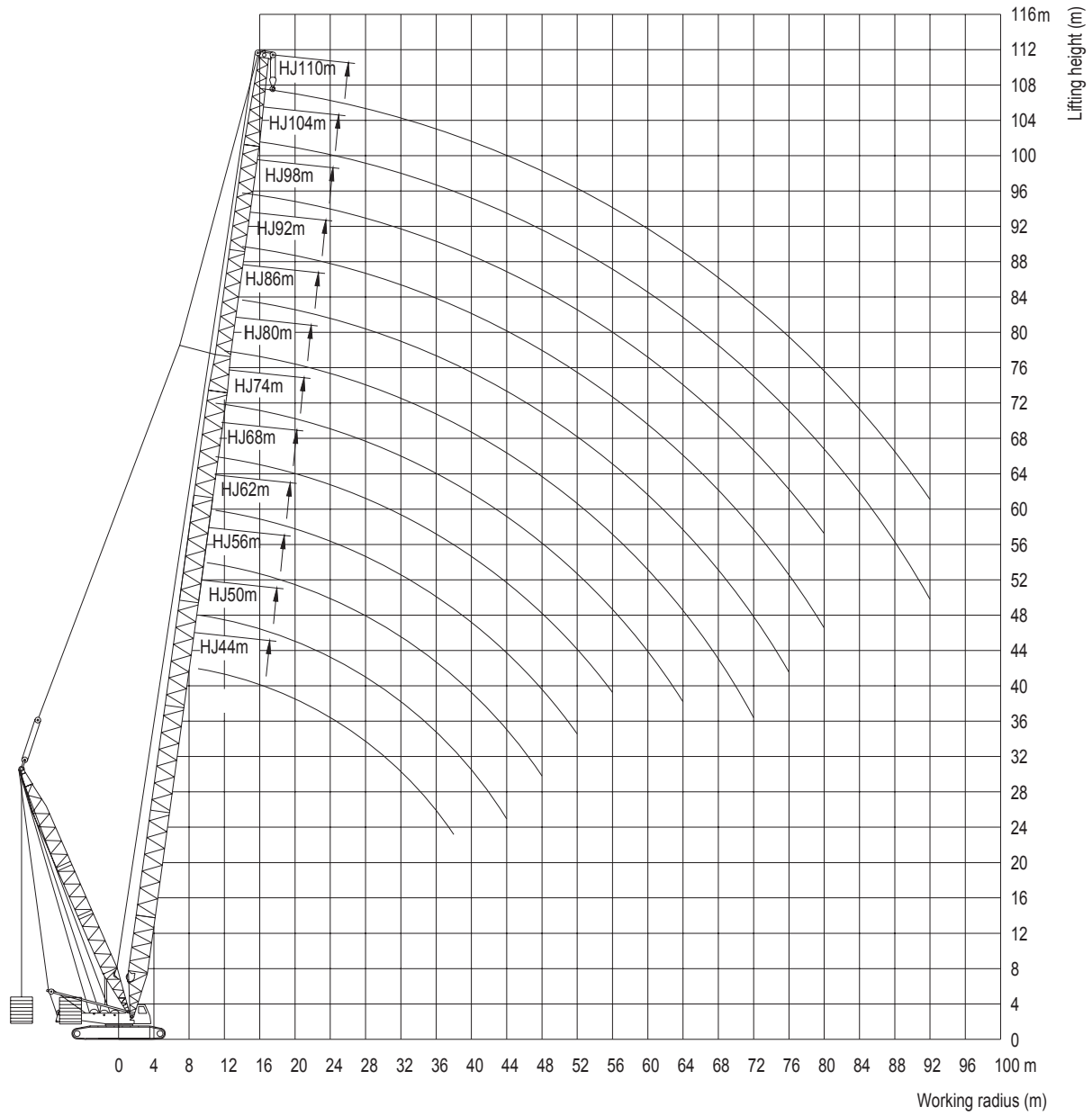

Working range curve

LOAD CHARTS OF HJDB OPERATING CONDITION

SCC4000E Crawler Crane - HJDB Load Chart

Mixed boom 44-110m, Superlift mast 30m Rear counterweight 135t, Superlift counterweight 0-250t, Central counterweight 40t

Boom length(m) Radius(m)	44	50	56	62	68	74	80	86	92	98	104	110	Unit: (t)
9	198	198											9
10	198	198	191										10
11	198	189	181	168	155	142							11
12	189	189	179	168	154	141	123						12
14	189	189	179	165	153	139	120	107	102	86			14
16	189	187	176	163	151	134	116	102	101	84	81	63	16
18	187	184	174	159	145	130	110	98	97	82	80	63	18
20	184	181	172	153	139	124	105	93	91	79	78	62	20
22	181	179	167	146	131	118	100	90	87	77	76	62	22
24	179	176	163	141	125	112	95	86	83	74	74	61	24
26	175	172	156	135	120	106	89	82	79	70	70	60	26
28	171	164	150	129	113	101	85	78	75	67	67	58	28
30	165	155	144	123	108	97	81	74	71	65	63	56	30
32	153	148	137	118	103	91	78	70	68	62	61	55	32
34	144	141	130	112	98	87	74	67	65	59	58	53	34
36	134	133	124	107	93	83	69	64	62	57	56	49	36
38	127	128	119	101	89	79	66	62	60	55	54	47	38
40		122	114	97	85	75	63	59	57	52	50	46	40
44		109	103	87	77	67	58	56	54	48	47	43	44
48			92	79	68	61	55	53	50	45	44	40	48
52				70	62	54	51	50	48	42	41	37	52
56					56	48	43	48	46	39	38	34	56
60						43	42	47	44	36	36	32	60
64							39	40	45	42	34	30	64
68								38	44	41	32	29	68
72									37	42	39	30	72
76										40	38	29	76
80											36	28	80
84												27	84
88													88
92													92
Wind velocity (m/s)	12.8			11.1				9			Wind velocity (m/s)		

! Attention: When the 80~110m boom is raised under the operating condition, the superlift counterweight must be used; otherwise the crane is at the risk of tipping over!

Description: 1. The actual lifting capacity must be obtained by deducting the weight of lifting hook, hoisting tools, and wire rope wound around the lifting hook and boom head from the rated lifting capacity in the table.

2. The rated load indicated in the table is the weight hoisted slowly and stably on a level and hard soil ground.

H_L OPERATING CONDITION

Boom length m	Insert			
	6 m	12m	Light-duty12m I	Light-duty12m II
24	1	—	—	—
30	—	1	—	—
36	1	1	—	—
42	—	2	—	—
48	1	2	—	—
54	—	3	—	—
60	1	3	—	—
66	—	3	1	—
72	1	3	1	—
78	—	3	1	1
84*	1	3	1	1

* Indicates that the mid-point suspension cable must be used for 84m boom; otherwise the boom is at the risk of fracture.

! Attention: When the 84m arm and 135t rear counterweight are raised under the operating condition, the side lifting outrigger must be used for raising arm sideward. Otherwise the crane will be at the risk of tipping over!

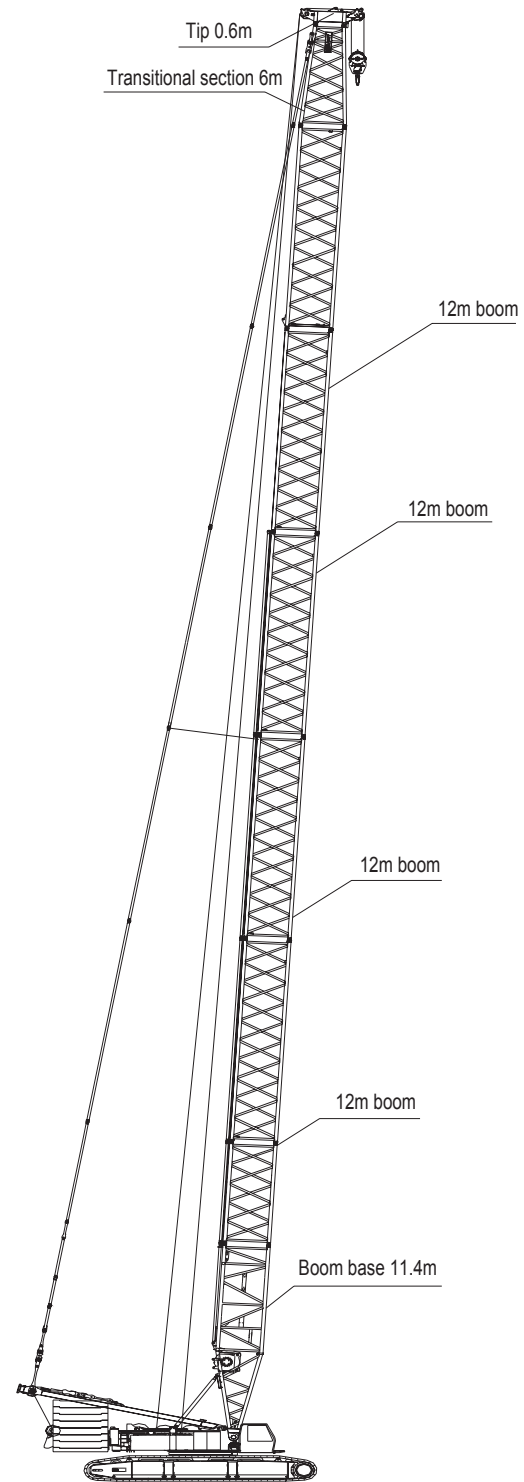

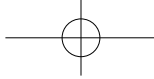

OPERATING RANGE DIAGRAM OF H_L OPERATING CONDITION

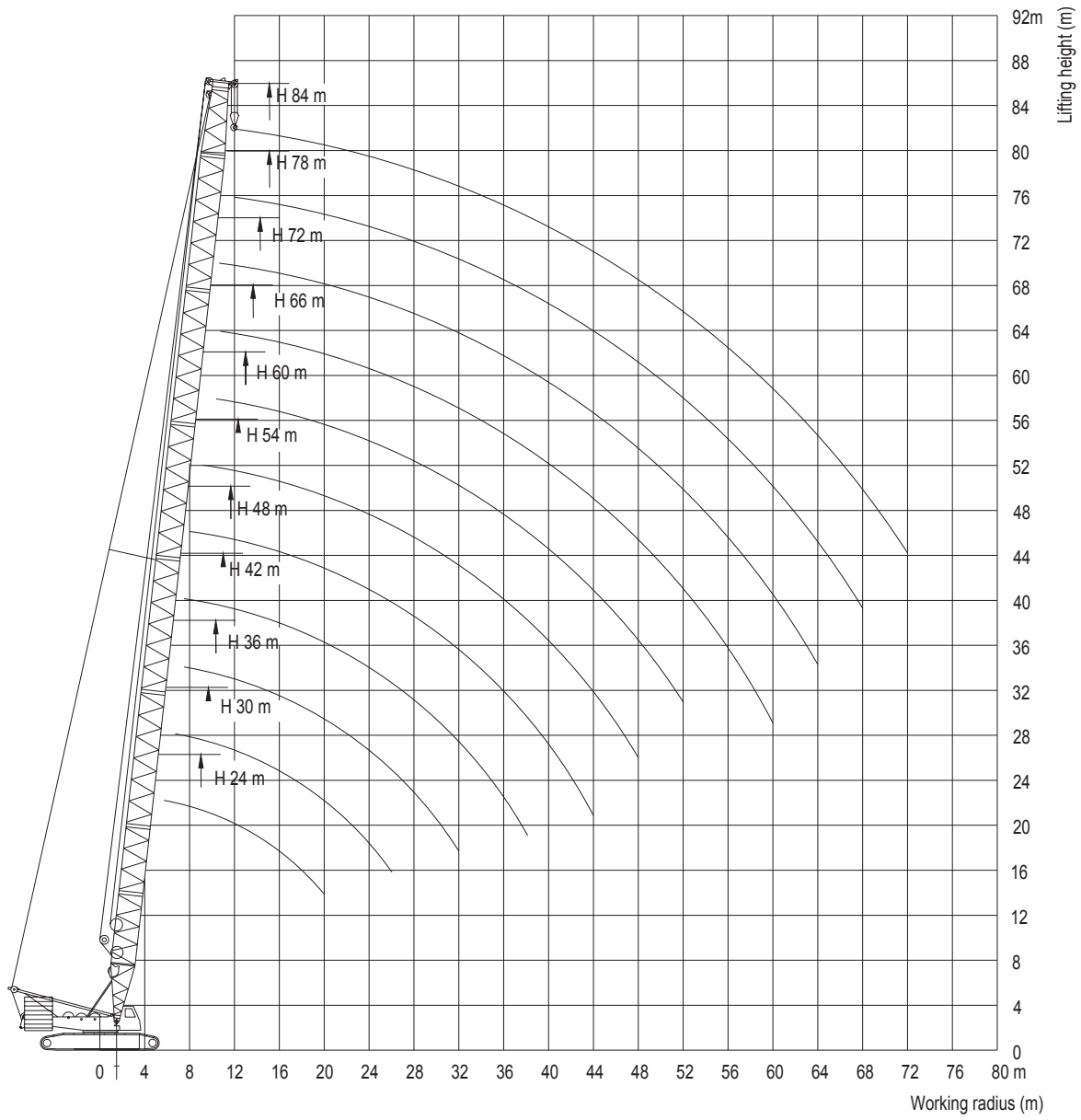

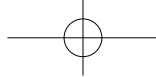

LOAD CHARTS OF H_L OPERATING CONDITION

SCC4000E Crawler Crane - Load Chart of Light-duty Boom (H_L) Operating Condition

Boom 24m-84m Rear counterweight 135t Central counterweight 40t

Unit: (t)

Boom length(m) Radius(m)	24	30	36	42	48	54	60	66	72	78	84	Boom length(m) Radius(m)
4.5	250											4.5
5	250											5
5.5	250											5.5
6	250	250										6
6.5	250	250										6.5
7	250	250	250	250								7
8	240	232	229	224	218							8
9	215	210	205	200	192	180						9
10	195	190	185	180	173	162	153	148				10
11	177	172	169	163	155	147	139	133	125			11
12	160	157	154	149	140	132	128	123	116	112.1	106.1	12
14	130	130	128	124	120	112	110	103	99	96.8	92.8	14
16	108	107	105	102	101	96	95	90	86	84.4	80.7	16
18	92	91	88.5	87	86	84	83	80	74	73.1	70.1	18
20	80	78	76.5	76	75.5	74	72	72	65	63.4	61.5	20
22		69	67	66	66	65	63.5	62.5	57	55.1	53.0	22
24		60	59	58	57.5	57	57	55	50.5	50.5	47.9	24
26		55	53	52	51	50	50	49	45.5	44.8	42.4	26
28			48	47	46	45	45	44	40.5	41.2	39.8	28
30			43	42	41.5	40.5	40.5	39.5	36.5	37.7	36.5	30
32			39.5	37.5	38	36.5	36.5	35.5	33	33.0	31.9	32
34				35	34	33	33	32	29.5	29.9	29.3	34
36				32	31	30	30	29	27	26.7	26.2	36
38				29.5	29	27.5	27.5	26.5	24	24.6	24.1	38
40					26.5	25.2	25.2	24	21.5	22.0	21.6	40
44					22.5	21.5	21	20	18	17.8	17.5	44
48						18.6	18	17.5	15	15.2	14.9	48
52							15.5	15	12	12.6	12.3	52
56								12.5	9	9.3	8.8	56
60								10.5	7	6.9	6.5	60
64									5.5	5.7	5.3	64
68										4.5	4.2	68
72											3	72
Radius(m) Boom length(m)			36	42	48	54	60	66	72	78	84	Radius(m) Boom length(m)

! Attention: When the 84m boom is raised under the operating condition, the side lifting outrigger must be used for raising arm sideward. Otherwise the crane will be at the risk of tipping over!

Description: 1. The actual lifting capacity must be obtained by deducting the weight of lifting hook, hoisting tools, and wire rope wound around the lifting hook and boom head from the rated lifting capacity in the table.
2. The rated load indicated in the table is the weight hoisted slowly and stably on a level and hard soil ground.

LOAD CHARTS OF H_L OPERATING CONDITION

SCC4000E Crawler Crane - Load Chart of Light-duty Boom (H_L) Operating Condition

Boom 24m-84m Rear counterweight 155t Central counterweight 40t

Unit: (t)

Boom length(m) Radius(m)	24	30	36	42	48	54	60	66	72	78	84	Boom length(m) Radius(m)
7			250	250								7
8		240	236	230	226							8
9		215	212	205	202	193						9
10	200	195	192	185	182	174	165	150				10
11	182	177	175	169	165	158	151	143	129			11
12	165	162	159	155	150	144	138	132	126	117.2	107.0	12
14	142	140	136	130	127	122	118.5	112	108	107.0	97.0	14
16	118	118	116	112	109	105	100.5	97	94	94.7	90.5	16
18	98	98	97	96	95	92	87	85	81.5	82.9	80.7	18
20	86	85	84	82	82	81	78	76	72.5	73.1	71.6	20
22		72	75	72	71	72	70	68	65.5	65.9	64.6	22
24		64	65	63	63	64	63	61	59	59.7	58.5	24
26		58	59	56	56	57	56	55	53.5	54.0	52.4	26
28			54	51	50	51	50	49	48.5	49.4	47.4	28
30			48	46	45	46	46	45	44	45.6	43.7	30
32			43	42	41	41.5	41.5	40.5	39.5	40.9	39.6	32
34				38	36.5	38	38	37	36	37.2	36.0	34
36				35	33	34.5	34.5	34	33.5	34.6	33.4	36
38				32	31	32	32	31	30.5	31.5	30.3	38
40					28	29	29	28.5	28	28.8	27.7	40
44					25	25	25	24	23.5	24.1	23.1	44
48						21	21	21	20	20.4	19.5	48
52							18.5	18	16.8	17.0	16.2	52
56								15	14.2	14.1	13.2	56
60								13	12	12.4	11.7	60
64									10.2	10.6	10.1	64
68										8.1	7.8	68
72											6.2	72
76											5.0	76
Radius(m) Boom length(m)			36	42	48	54	60	66	72	78	84	Radius(m) Boom length(m)

! Attention: When the 84m boom is raised under the operating condition, the side lifting outrigger must be used for raising arm sideward. Otherwise the crane will be at the risk of tipping over!

Description: 1. The actual lifting capacity must be obtained by deducting the weight of lifting hook, hoisting tools, and wire rope wound around the lifting hook and boom head from the rated lifting capacity in the table.

2. The rated load indicated in the table is the weight hoisted slowly and stably on a level and hard soil ground.

SF_L OPERATING CONDITION

Boom length m	Boom insert					Component of fixed short jib
	3 m	6 m	12m	Light-duty 12m I	Light-duty 12m II	
36	—	1	—	1	—	1
42	—	—	1	1	—	1
48	—	1	1	1	—	1
54	—	—	2	1	—	1
60	—	1	2	1	—	1
66	—	—	3	1	—	1
72	—	1	3	1	—	1
78	—	—	3	1	1	1
84*	—	1	3	1	1	1
87*	1	1	3	1	1	1

* Indicates that when the length of boom is 84m, the mid-point suspension cable must be used; otherwise the arm support has risk of fracture;

! Attention: When the 84m arm is raised under the operating condition, the side lifting outrigger must be used for raising arm sideward. Otherwise the crane will be at the risk of tipping over!

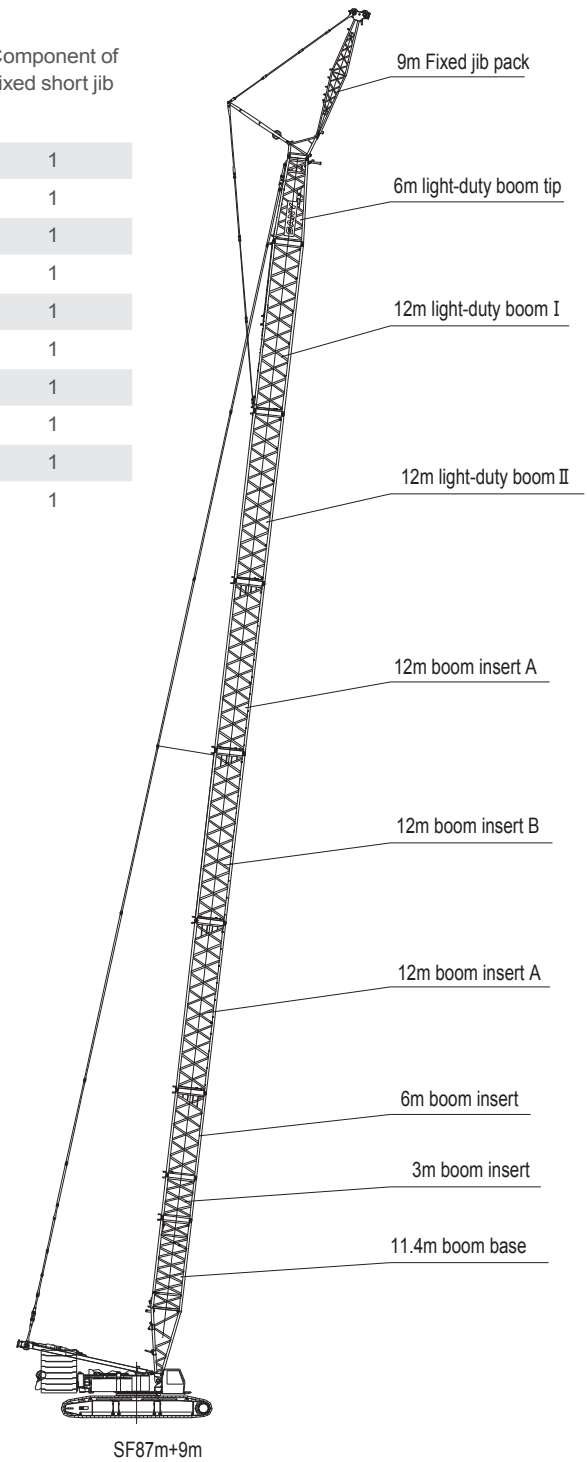



OPERATING RANGE (12°) DIAGRAM OF SF_L OPERATING CONDITION

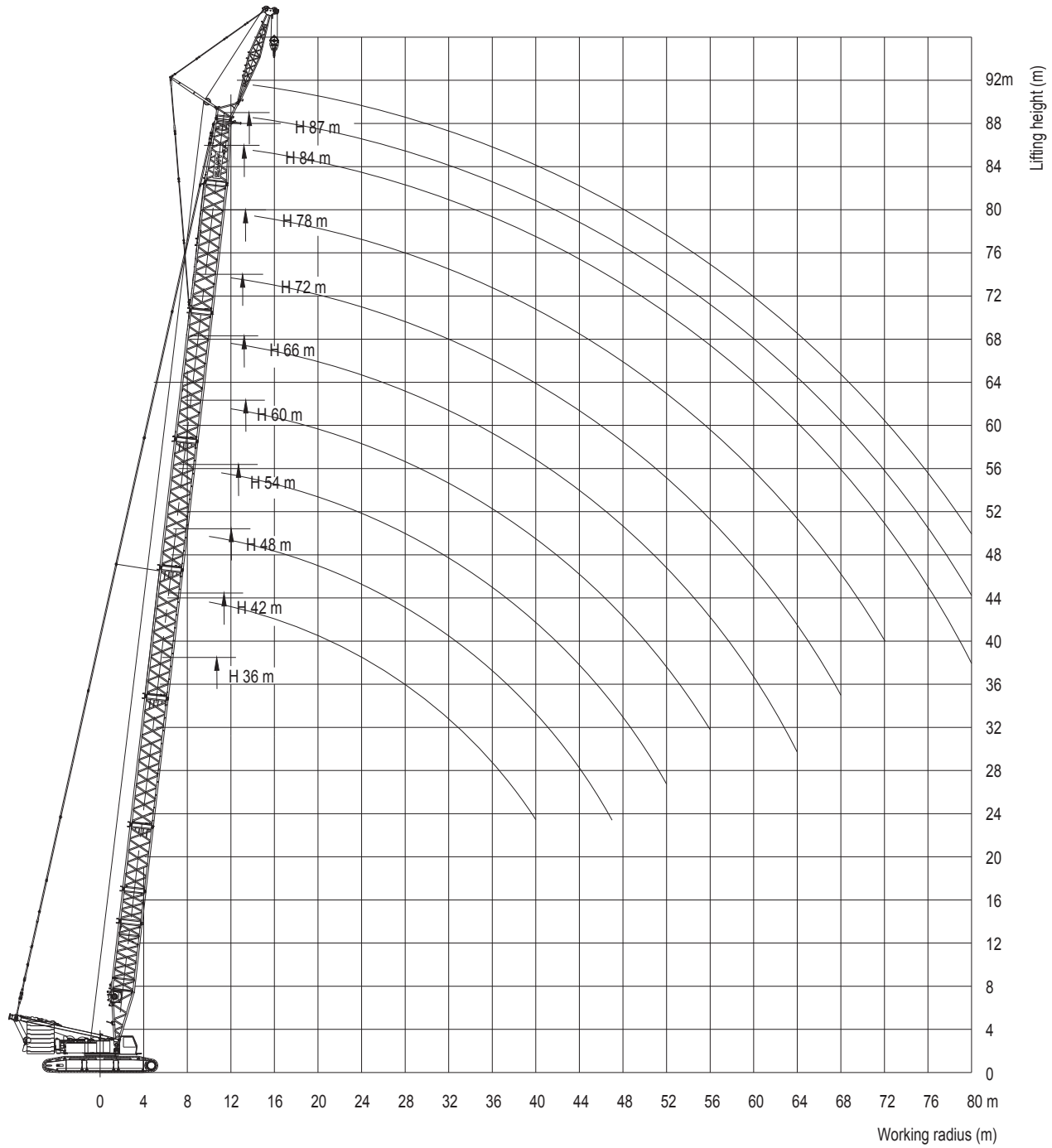



LOAD CHARTS OF SF_L OPERATING CONDITION

SCC4000E Crawler Crane - Load Chart of 9m Fixed-Jib Operating Condition SF_L12(12°)

Rear counterweight 155 Central counterweight 40t Central counterweight 40t

Unit: (t)

Boom length(m) Radius(m)	36	42	48	54	60	66	72	78	81	84	Boom length(m) Radius(m)
10	108.0										10
11	108.0	108.0	108.0								11
12	108.0	108.0	108.0	108.0	108.0	108.0					12
14	108.0	108.0	108.0	108.0	108.0	108.0	108.0	108.0	108.0	103(15m)	14
16	106.0	108.0	108.0	107.0	107.0	107.0	105.0	103.5	103.0	98.0	16
18	98.0	104.0	107.0	104.0	102.0	100.5	100.0	100.0	98.8	94.0	18
20	91.0	91.9	91.3	90.8	86.5	86.5	86.0	85.5	83.0	78.6	20
22	80.6	80.0	79.4	78.8	79.9	77.8	74.8	72.6	69.8	67.8	22
24	69.5	69.0	68.4	67.8	67.1	66.5	65.8	65.7	63.1	61.1	24
26	62.5	61.9	61.3	60.6	59.9	59.2	58.5	58.4	57.3	55.3	26
28	56.5	56.0	55.3	54.6	53.9	53.0	52.4	52.3	51.3	49.2	28
30	51.5	51.0	50.0	49.5	48.5	48.0	47	47.1	46.1	45.0	30
32	47.0	46.5	45.5	45.2	44.0	43.0	43	43	42	40	32
34	43.0	42.5	42.0	41.4	40.0	39.0	39	39	38	36	34
36	40.0	39.5	38.5	38.1	37.0	36.0	36	35	34	33	36
38	37.0	36.5	35.5	35.1	34.0	33.0	33	33	31	30	38
40	34.0	34.0	33.0	32.5	31.0	30.0	30	30	29	27	40
44		29.5	28.5	28.1	27.0	26.0	26	25	24	23	44
48		26.0	25.0	24.4	23.0	22.0	22	22	21	20	48
52			22.0	21.4	20.0	19.0	19	19	17	17	52
56				18.8	17.0	16.5	16	16	15	14	56
60					15.0	14.0	14	14	13	12	60
64					13.0	12.0	12	12	11	10	64
68						10.5	10	10	9	9	68
72							9	9	7	7	72
76								7	6	6	76
80									5	5	80

! Attention: When the 84m boom is raised under the operating condition, the side lifting outrigger must be used for raising arm sideward. Otherwise the crane will be at the risk of tipping over!

Description: 1. The actual lifting capacity must be obtained by deducting the weight of lifting hook, hoisting tools, and wire rope wound around the lifting hook and boom head from the rated lifting capacity in the table.

2. The rated load indicated in the table is the weight hoisted slowly and stably on a level and hard soil ground.

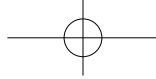

OPERATING RANGE (20°) DIAGRAM OF SF_L OPERATING CONDITION

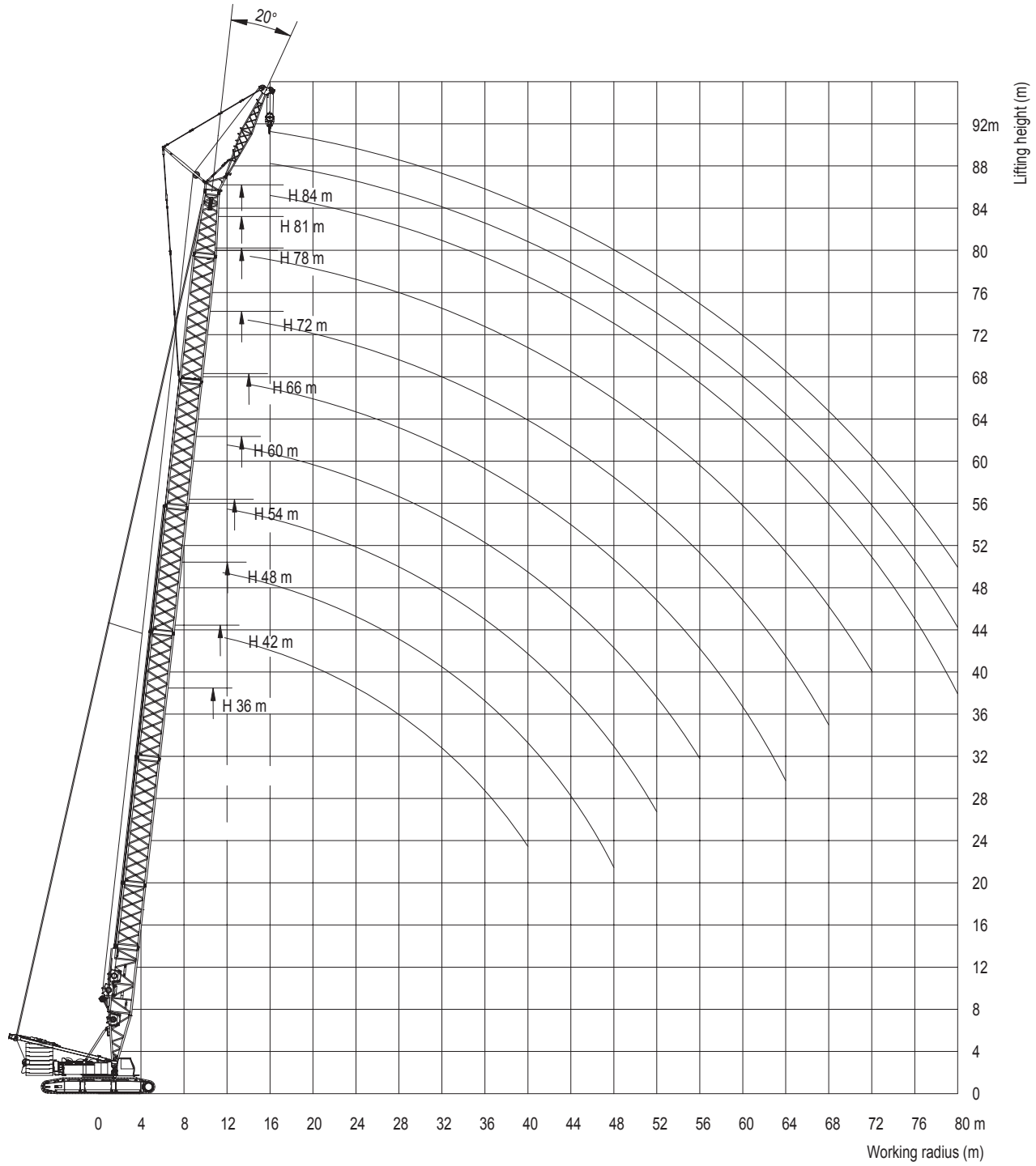

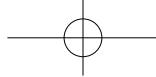

LOAD CHARTS OF SF_L OPERATING CONDITION

SCC4000E Crawler Crane - Load Chart of 9m Fixed-Jib Operating Condition SF_L20(20°)

Rear counterweight 155t Central counterweight 40t

Unit: (t)

Boom length(m) Radius(m)	36	42	48	54	60	66	72	78	81	84	Boom length(m) Radius(m)
11	98.0	99.0									11
12	94.0	96.0	98.0	99.0							12
14	88.0	91.0	94.0	96.0	98.0	100.0	101.0	101(15m)	102(15m)		14
16	82.0	85.0	88.0	90.5	93.0	95.0	97.0	99.0	99.0	96.0	16
18	77.0	80.0	83.0	86.0	88.0	90.0	93.0	91.0	88.0	85.0	18
20	73.0	75.0	78.0	81.0	84.0	86.0	85.0	81.0	78.5	75.0	20
22	68.0	71.0	74.5	77.0	80.0	79.9	79.3	75.0	71.0	68.0	22
24	64.0	66.0	68.5	68.0	70.0	69.5	68.8	68.0	64.0	62.0	24
26	62.5	62.0	61.5	61.0	62.0	61.4	60.7	60.6	58.0	56.0	26
28	56.5	56.0	55.5	54.5	54.0	53.6	52.9	52.0	53.0	51.0	28
30	51.5	51.0	50.5	49.5	49.0	48.4	47.7	47.0	48.0	46.0	30
32	47.0	46.5	46.0	45.0	44.5	44.0	43.2	43.0	42.1	41.0	32
34	43.5	43.0	42.0	41.5	40.5	40.0	39.4	39.0	38.2	37.0	34
36	40.0	39.5	39.0	38.0	37.5	36.5	36.0	35.0	34.8	34.0	36
38	37.0	36.5	36.0	35.0	34.5	33.5	33.0	32.0	31.8	31.0	38
40	34.5	34.0	33.0	32.5	31.5	31.0	30.3	30.0	29.1	28.0	40
44		29.5	28.5	28.0	27.0	26.3	25.8	25.0	24.5	24.0	44
48		26.0	25.0	24.5	23.5	22.5	22.1	21.0	20.8	20.0	48
52			22.0	21.5	20.5	19.5	19.0	18.0	17.7	17.0	52
56				18.8	18.0	17.0	16.3	16.0	15.0	14.0	56
60					15.7	15.0	14.1	13.0	12.7	12.0	60
64					13.7	13.0	12.1	11.5	10.7	10.0	64
68						11.0	10.4	10.0	9.0	8.0	68
72							8.8	8.0	7.5	6.0	72
76								7.0	6.1	5.0	76
80								5.5	4.8	4.0	80
80									5	5	80

! Attention: When the 84m boom is raised under the operating condition, the side lifting outrigger must be used for raising arm sideward. Otherwise the crane will be at the risk of tipping over!

Description: 1. The actual lifting capacity must be obtained by deducting the weight of lifting hook, hoisting tools, and wire rope wound around the lifting hook and boom head from the rated lifting capacity in the table.

2. The rated load indicated in the table is the weight hoisted slowly and stably on a level and hard soil ground.

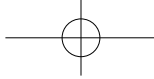

Notes

Area with horizontal dashed lines for notes.



Notes

Area with horizontal dashed lines for notes.

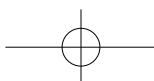
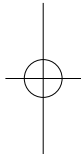
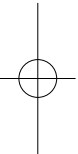



Quality Changes the World

SANY GROUP CO., LTD.

Address: SANY Industrial Park, Economic and Technological
Development Zone, Changsha, Hunan, China

Service Hotline: +0086-4006-098-318

E-mail: crd@sany.com.cn

For more information, please visit: www.sanygroup.com

B05S2ENAM1-SCC4000E

